

FM Stereo FM-AM Receiver

Operating Instructions

*STR-DB940
STR-DB840*

WARNING

To prevent fire or shock hazard, do not expose the unit to rain or moisture.

For customers in the United States

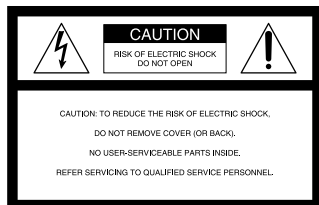

This symbol is intended to alert the user to the presence of uninsulated "dangerous voltage" within the product's enclosure that may be of sufficient magnitude to constitute a risk of electric shock to persons.



This symbol is intended to alert the user to the presence of important operating and maintenance (servicing) instructions in the literature accompanying the appliance.

INFORMATION

This equipment has been tested and found to comply with the limits for a Class B digital device, pursuant to Part 15 of the FCC Rules. These limits are designed to provide reasonable protection against harmful interference in a residential installation. This equipment generates, uses, and can radiate radio frequency energy and, if not installed and used in accordance with the instructions, may cause harmful interference to radio communications. However, there is no guarantee that interference will not occur in a particular installation. If this equipment does cause harmful interference to radio or television reception, which can be determined by turning the equipment off and on, the user is encouraged to try to correct the interference by one or more of the following measures:

- Reorient or relocate the receiving antenna.
- Increase the separation between the equipment and receiver.
- Connect the equipment into an outlet on a circuit different from that to which the receiver is connected.
- Consult the dealer or an experienced radio/TV technician for help.

CAUTION

You are cautioned that any changes or modification not expressly approved in this manual could void your authority to operate this equipment.

Note to CATV system installer:

This reminder is provided to call CATV system installer's attention to Article 820-40 of the NEC that provides guidelines for proper grounding and, in particular, specifies that the cable ground shall be connected to the grounding system of the building, as close to the point of cable entry as practical.

Owner's Record

The model and serial numbers are located on the rear of the unit. Record the serial number in the space provided below. Refer to them whenever you call upon your Sony dealer regarding this product.

Model No. STR-DB940/DB840

Serial No. _____



ENERGY STAR® is a U.S. registered mark. As an ENERGY STAR® partner, Sony Corporation has determined that this product meets the ENERGY STAR® guidelines for energy efficiency.

For customers in Canada

CAUTION

TO PREVENT ELECTRIC SHOCK, DO NOT USE THIS POLARIZED AC PLUG WITH AN EXTENSION CORD, RECEPTACLE OR OTHER OUTLET UNLESS THE BLADES CAN BE FULLY INSERTED TO PREVENT BLADE EXPOSURE.

For customers in Europe

To avoid electrical shock, do not open the cabinet. Refer servicing to qualified personnel only.

Do not install the appliance in a confined space, such as a bookcase or built-in cabinet.



A946

Precautions

On safety

Should any solid object or liquid fall into the cabinet, unplug the receiver and have it checked by qualified personnel before operating it any further.

On power sources

- Before operating the receiver, check that the operating voltage is identical with your local power supply. The operating voltage is indicated on the nameplate at the rear of the receiver.
- The unit is not disconnected from the AC power source (mains) as long as it is connected to the wall outlet, even if the unit itself has been turned off.
- If you are not going to use the receiver for a long time, be sure to disconnect the receiver from the wall outlet. To disconnect the AC power cord, grasp the plug itself; never pull the cord.
- One blade of the plug is wider than the other for the purpose of safety and will fit into the wall outlet only one way. If you are unable to insert the plug fully into the outlet, contact your dealer.
- AC power cord must be changed only at the qualified service shop.

On placement

- Place the receiver in a location with adequate ventilation to prevent heat buildup and prolong the life of the receiver.
- Do not place the receiver near heat sources, or in a place subject to direct sunlight, excessive dust or mechanical shock.
- Do not place anything on top of the cabinet that might block the ventilation holes and cause malfunctions.

On operation

Before connecting other components, be sure to turn off and unplug the receiver.

On cleaning

Clean the cabinet, panel and controls with a soft cloth slightly moistened with a mild detergent solution. Do not use any type of abrasive pad, scouring powder or solvent such as alcohol or benzene.

If you have any question or problem concerning your receiver, please consult your nearest Sony dealer.

About This Manual

The instructions in this manual are for models STR-DB940 and STR-DB840. Check your model number by looking at the lower right corner of the front panel. In this manual, the STR-DB940 is used for illustration purposes unless stated otherwise. Any difference in operation is clearly indicated in the text, for example, "STR-DB940 only."

Type of differences

Model	DB940	DB840
5 audio inputs	●	
4 audio inputs		●

About area codes

The area code of the player you purchased is shown on the lower portion of the rear panel (see the illustration below).

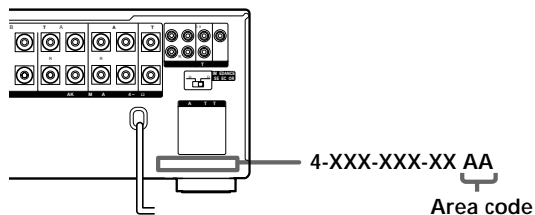

Any differences in operation, according to the area code, are clearly indicated in the text, for example, "Models of area code AA only".

Conventions

- The instructions in this manual describe the controls on the receiver. You can also use the controls on the supplied remote if they have the same or similar names as those on the receiver. For details on the use of your remote, refer to the separate operating instructions supplied with the remote.
- The following icon is used in this manual:
 Indicates hints and tips for making the task easier.

This receiver incorporates Dolby* Digital and Pro Logic Surround and the DTS** Digital Surround System.

* Manufactured under license from Dolby Laboratories. "Dolby", "AC-3", "Pro Logic" and the double-D symbol  are trademarks of Dolby Laboratories. Confidential unpublished Works. © 1992-1997 Dolby Laboratories. All rights reserved.

**Manufactured under license from Digital Theater Systems, Inc. US Pat. No. 5,451,942 and other worldwide patents issued and pending. "DTS" and "DTS Digital Surround" are trademarks of Digital Theater Systems, Inc. © 1996 Digital Theater Systems, Inc. All rights reserved.

TABLE OF CONTENTS

Hooking Up the Components 4

Unpacking	4
Antenna Hookups	5
Audio Component Hookups	6
Video Component Hookups	8
Digital Component Hookups	9
5.1CH Input Hookups	11
Other Hookups	12

Hooking Up and Setting Up the Speaker System 15

Speaker System Hookup	16
Performing Initial Setup Operations	18
Multi Channel Surround Setup	19
Before You Use Your Receiver	23

Location of Parts and Basic Operations 26

Front Panel Parts Description	26
-------------------------------	----

Enjoying Surround Sound 31

Selecting a Sound Field	32
Understanding the Multi-Channel Surround Displays	36
Customizing Sound Fields	38

Receiving Broadcasts 43

Storing FM Stations Automatically (AUTOBETICAL)**	44
Direct Tuning	45
Automatic Tuning	45
Preset Tuning	46
Using the Radio Data System (RDS)**	47

***Models of area code CED only.

Other Operations 50

Naming Preset Stations and Program Sources	51
Recording	51
Using the Sleep Timer	52
Adjustments Using the SET UP Button	53
CONTROL A1 II Control System	54

Additional Information 56

Troubleshooting	56
Specifications	58
Glossary	61
Tables of Settings Using SUR, LEVEL, EQ, and SET UP buttons	62
Index (Back cover)	

Hooking Up the Components

This chapter describes how to connect various audio and video components to the receiver. Be sure to read the sections for the components you have before you actually connect them to the receiver.

Unpacking

Check that you received the following items with the remote:

- FM wire antenna (1)
- AM loop antenna (1)

Models of area code U, CA only

- Audio/video/control S connecting cord (1)
- Control S connecting cord (1)

STR-DB940 only

- Remote commander RM-LJ304 (remote) (1)
- LR6 (size-AA) alkaline batteries (3)

STR-DB840 only

- Models of area code CED only
 - Remote commander RM-PP404 (remote) (1)
 - R6 (size-AA) batteries (2)
- Models of other area codes
 - Remote commander RM-LP204 (remote) (1)
 - LR6 (size-AA) alkaline batteries (3)

Inserting batteries into the remote

Insert batteries with the + and – properly oriented in the battery compartment. When using the remote, point it at the remote sensor  on the receiver.

For details, refer to the operating instructions supplied with your remote.



When to replace batteries

Under normal conditions, the batteries should last for about 3 months. When the remote no longer operates the receiver, replace all batteries with new ones.

Notes

- Do not leave the remote in an extremely hot or humid place.
- Do not use a new battery with an old one.
- Do not expose the remote sensor to direct sunlight or lighting apparatuses. Doing so may cause a malfunction.
- If you don't use the remote for an extended period of time, remove the batteries to avoid possible damage from battery leakage and corrosion.
- This remote is designed for use with alkaline batteries only. Do not use a combination of different battery types.

Before you get started

- Turn off the power to all components before making any connections.
- Do not connect the AC power cord until all of the connections are completed.
- Be sure to make connections firmly to avoid hum and noise.
- When connecting an audio/video cord, be sure to match the color-coded pins to the appropriate jacks on the components: yellow (video) to yellow; white (left, audio) to white; and red (right, audio) to red.

Antenna Hookups

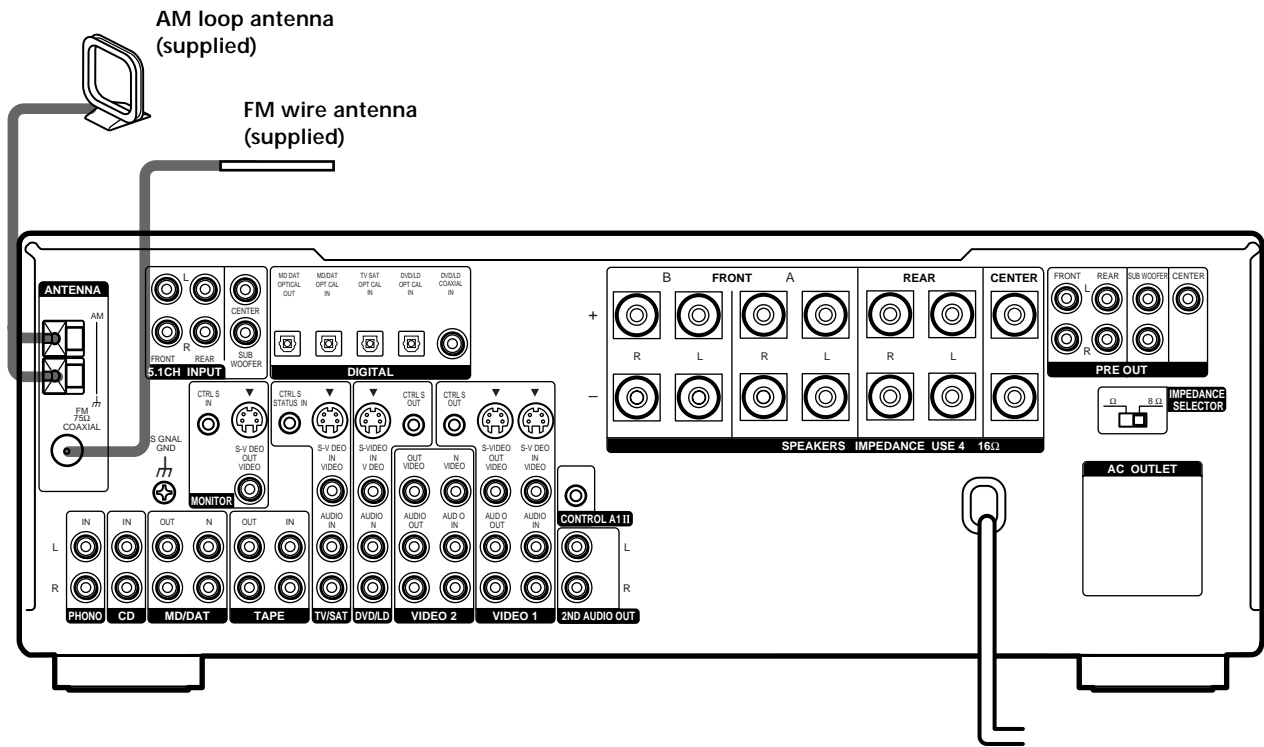

Terminals for connecting the antennas

Connect the	To the
AM loop antenna	AM terminals
FM wire antenna	FM 75Ω COAXIAL terminal

Assembling the supplied FM antenna (Models of area code U, CA only)

The supplied FM wire antenna must be connected to the supplied FM antenna adaptor.

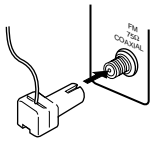

Notes on antenna hookups

- To prevent noise pickup, keep the AM loop antenna away from the receiver and other components.
- Be sure to fully extend the FM wire antenna.
- After connecting the FM wire antenna, keep it as horizontal as possible.

💡 If you have poor FM reception
 Use a 75-ohm coaxial cable (not supplied) to connect the receiver to an outdoor FM antenna as shown below.

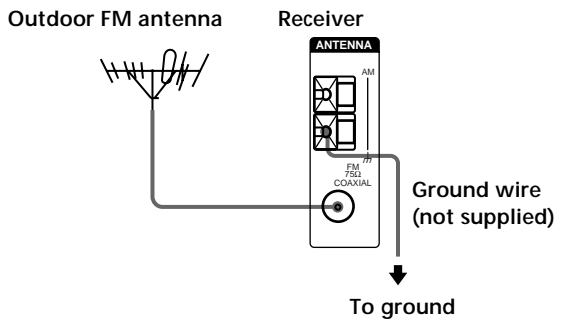

Important
 If you connect the receiver to an outdoor antenna, ground it against lightning. To prevent a gas explosion, do not connect the ground wire to a gas pipe.

Note
 Do not use the SIGNAL GND terminal for grounding the receiver.

Audio Component Hookups

STR-DB940

Hooking Up the Components

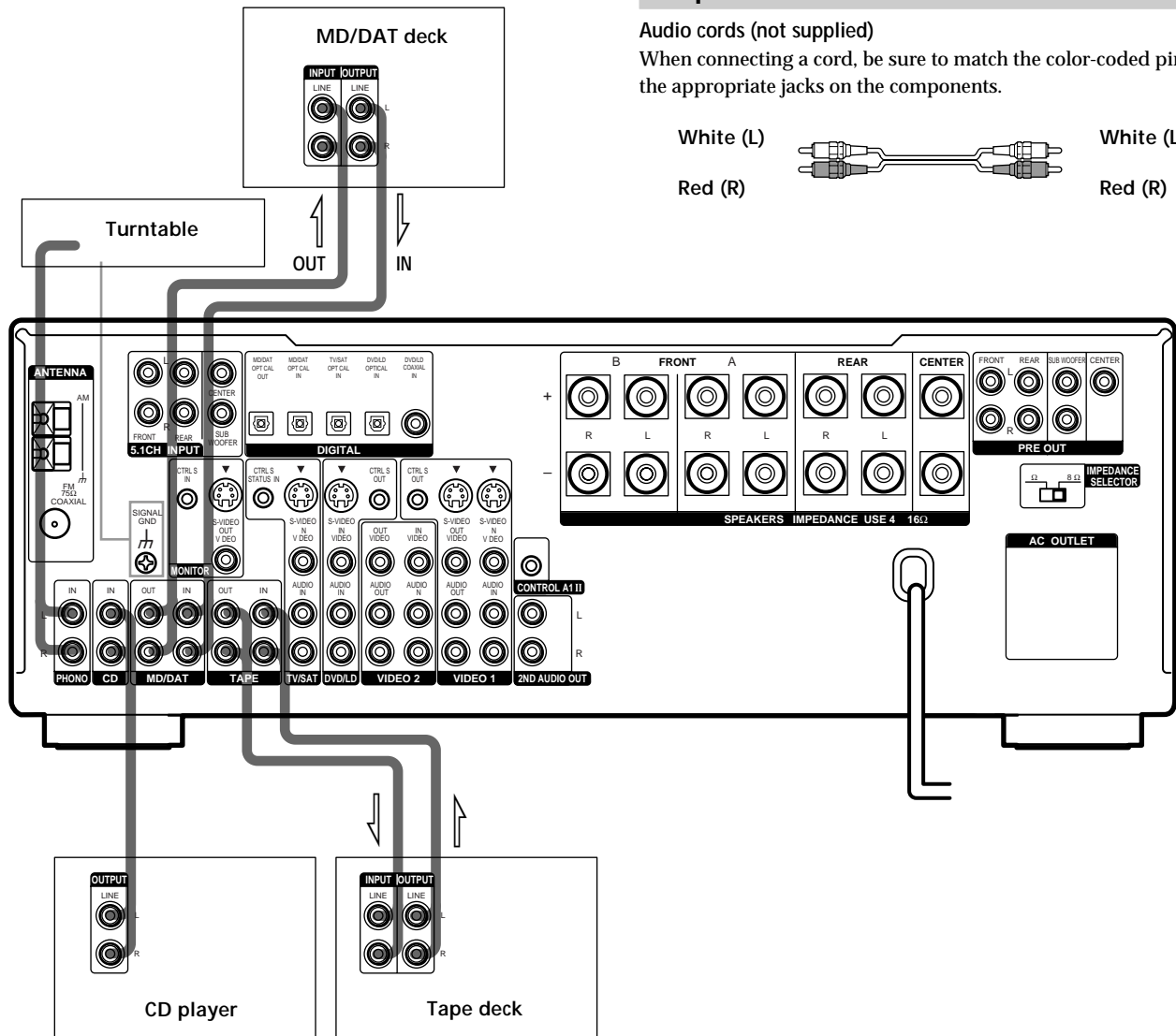

Required cords

Audio cords (not supplied)
When connecting a cord, be sure to match the color-coded pins to the appropriate jacks on the components.



Jacks for connecting audio components

Connect a	To the
Turntable	PHONO jacks
CD player	CD jacks
Tape deck	TAPE jacks
MD deck or DAT deck	MD/DAT jacks

Note on audio component hookups

If your turntable has a ground wire, connect it to the h SIGNAL GND terminal on the receiver.

STR-DB840

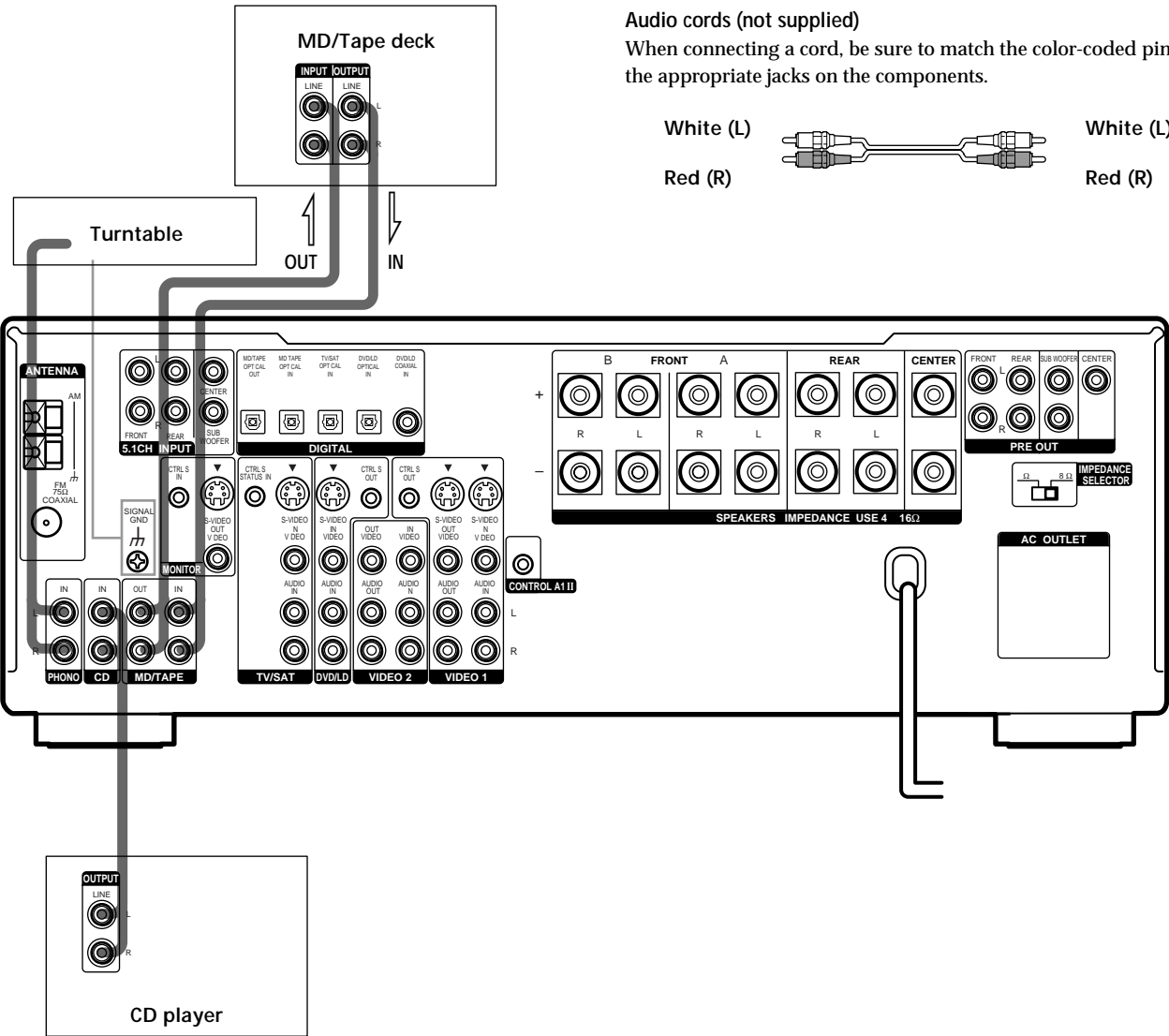

Required cords

Audio cords (not supplied)
When connecting a cord, be sure to match the color-coded pins to the appropriate jacks on the components.



Hooking Up the Components

Jacks for connecting audio components

Connect a	To the
Turntable	PHONO jacks
CD player	CD jacks
MD deck or tape deck	MD/TAPE jacks

Note on audio component hookups

If your turntable has a ground wire, connect it to the \hbar SIGNAL GND terminal on the receiver.

Video Component Hookups

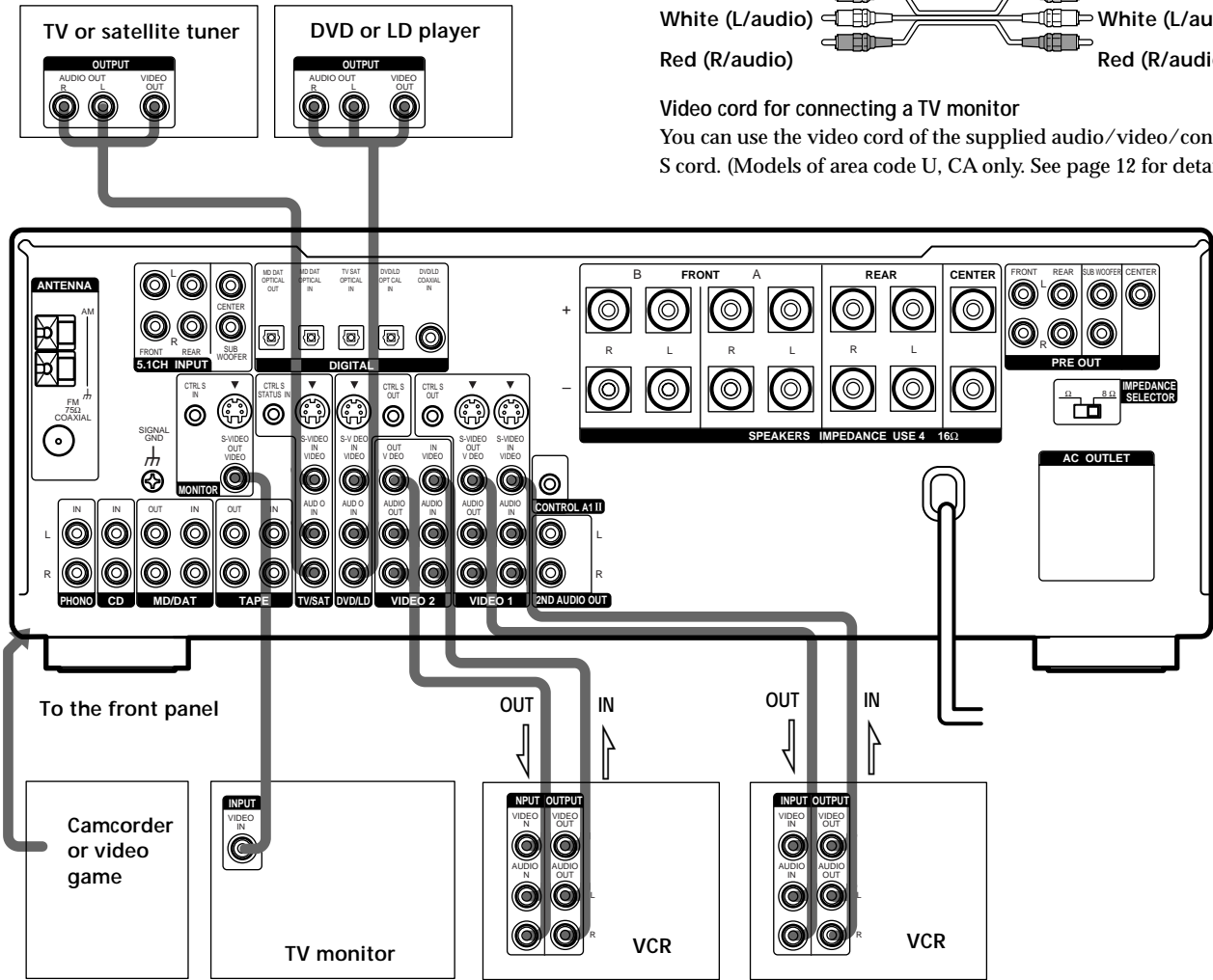

Required cords

Audio/video cords (not supplied)

When connecting a cord, be sure to match the color-coded pins to the appropriate jacks on the components.

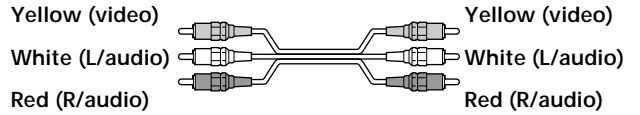

Video cord for connecting a TV monitor

You can use the video cord of the supplied audio/video/control S cord. (Models of area code U, CA only. See page 12 for details).

Jacks for connecting video components

Connect a	To the
TV or satellite tuner	TV/SAT jacks
VCR	VIDEO 1 jacks
Additional VCR	VIDEO 2 jacks
DVD or LD player	DVD/LD jacks
TV monitor ¹⁾	MONITOR VIDEO OUT jack
Camcorder or video game	VIDEO 3 INPUT jacks on the front panel

¹⁾ For STR-DB940, you can display the SURROUND, LEVEL, EQUALIZER parameters by pressing the ON SCREEN button on the remote.

Note on video component hookups

You can connect your TV's audio output jacks to the TV/SAT AUDIO IN jacks on the receiver and apply sound effects to the audio from the TV. In this case, do not connect the TV's video output jack to the TV/SAT VIDEO IN jack on the receiver. If you are connecting a separate TV tuner (or satellite tuner), connect both the audio and video output jacks to the receiver as shown above.

When using the S-video jacks instead of the video jacks
 Your monitor must also be connected via an S-video jack. S-video signals are on a separate bus from the video signals and will not be output through the video jacks.

Digital Component Hookups

Connect the digital output jacks of your DVD player and satellite tuner (etc.) to the receiver's digital input jacks to bring the multi channel surround sound of a movie theater into your home. To enjoy full effect of multi channel surround sound, five speakers (two front speakers, two rear speakers, and a center speaker) and a sub woofer are required. You can also connect an LD player with an RF OUT jack via an RF demodulator, like the Sony MOD-RF1 (not supplied).

Required cords

Optical digital cords (not supplied)

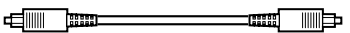

Black  Black

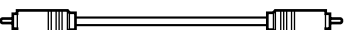
Coaxial digital cord (not supplied)

Yellow  Yellow

Audio/video cords (not supplied)

When connecting a cord, be sure to match the color-coded pins to the appropriate jacks on the components.

Yellow (video)  Yellow (video)
 White (L/audio)  White (L/audio)
 Red (R/audio)  Red (R/audio)

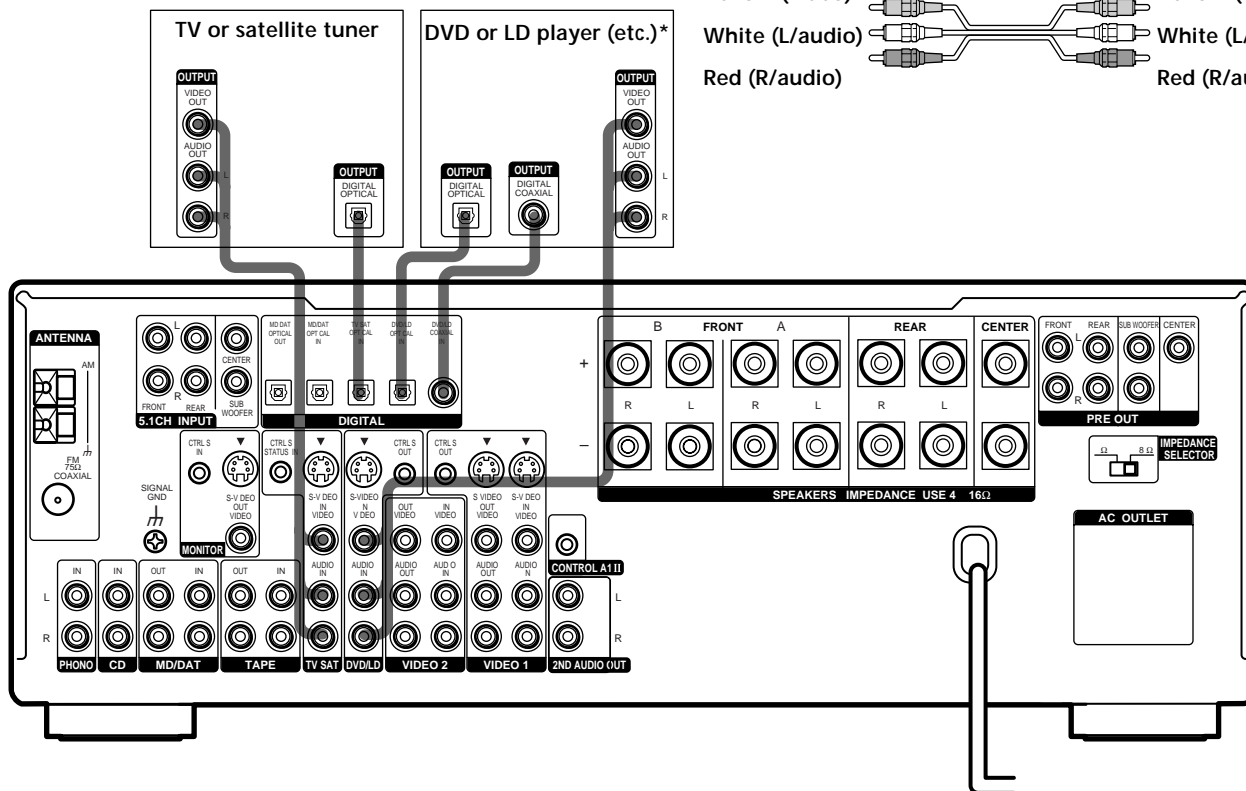

* Make either coaxial or optical connections. We recommend making coaxial connections instead of optical connections.

Example of LD player connected via an RF demodulator

Please note that you cannot connect an LD player's AC-3 RF OUT jack directly to this unit's digital input jacks. You must first convert the RF signal to either an optical or coaxial digital signal. Connect the LD player to the RF demodulator, then connect the RF demodulator's optical or coaxial digital output to this unit's OPTICAL or COAXIAL DVD/LD IN jack. Refer to the instruction manual supplied with your RF Demodulator for details on AC-3 RF hookups.

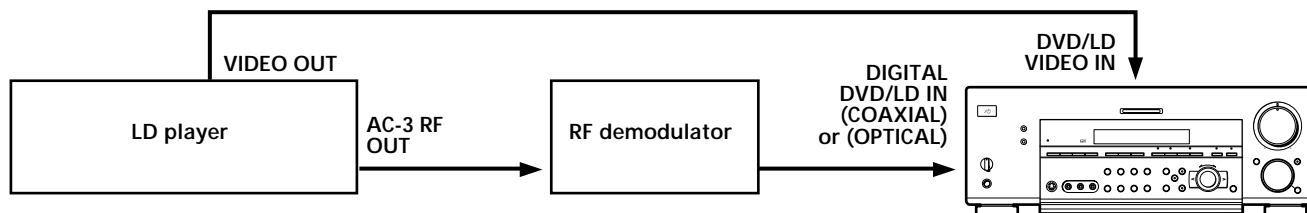

Note

When making connections as shown above, be sure to set INPUT MODE (5) on page 27) manually. This unit may not operate correctly if INPUT MODE is set to "AUTO."

Digital Component Hookups

Connect the digital output jacks of your MD or DAT deck to the receiver's digital input jack and connect the digital input jacks of your MD or DAT deck to the receiver's digital output jack. These connections allow you to make digital recordings of a CDs played back through your DVD (or LD player) and satellite broadcasts.

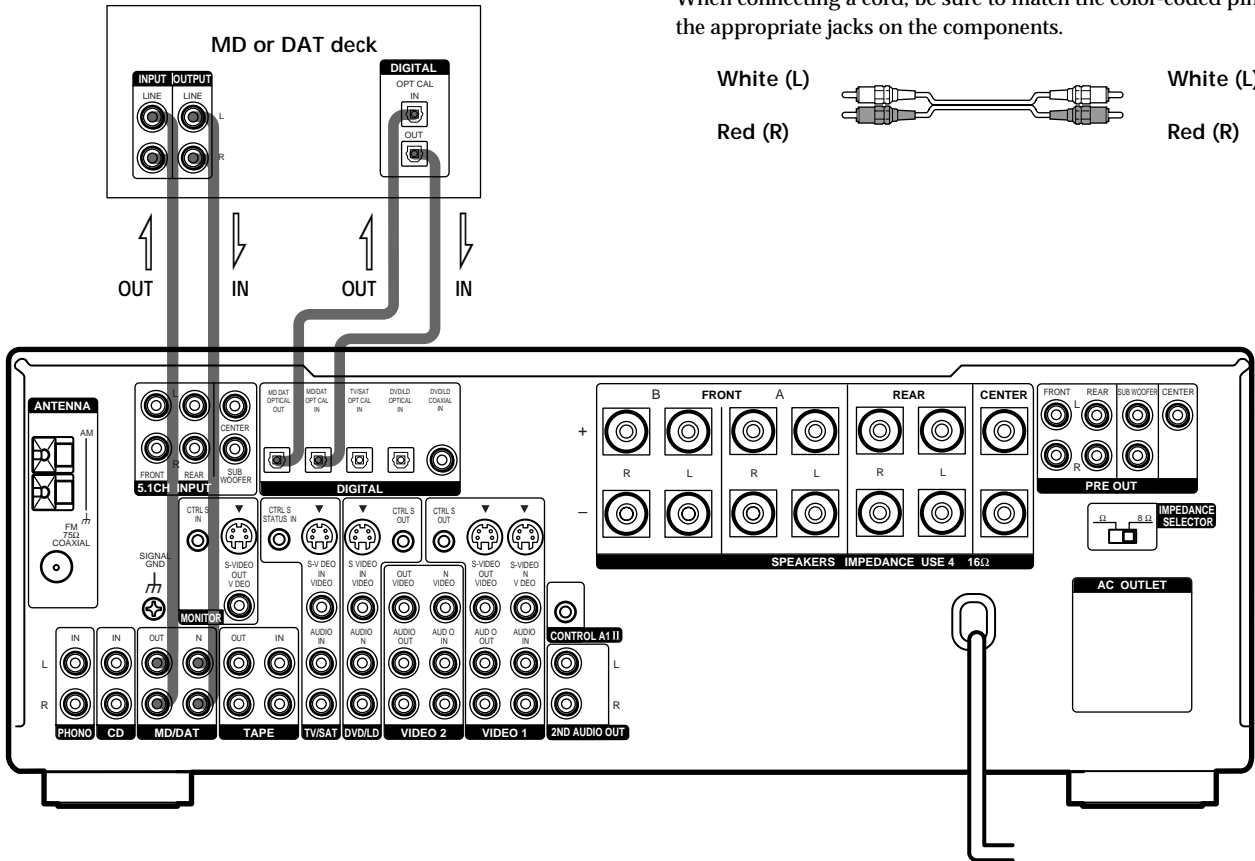

Required cords

Optical digital cords (not supplied)

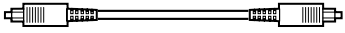
Black  Black

Audio cords (not supplied)

When connecting a cord, be sure to match the color-coded pins to the appropriate jacks on the components.

White (L)  White (L)
Red (R)  Red (R)

Notes

- Please note that you cannot make a digital recording of a digital multi channel surround signal.
- To make a digital recording from your CD player, connect the CD player's digital output directly to the digital input on your MD or DAT deck. Refer to the instructions supplied with your CD player and MD or DAT deck for details.
- The DVD/LD IN OPTICAL and COAXIAL jacks are compatible with 96 kHz, 48 kHz, 44.1 kHz and 32 kHz sampling frequencies. The other OPTICAL jacks are compatible with 48 kHz, 44.1 kHz and 32 kHz sampling frequencies.
- It is not possible to record analog signals to TAPE and VIDEO with only digital connections. To record analog signals, make analog connections. To record digital signals, make digital connections.
- Input signals with 96 kHz sampling frequencies to the DVD/LD IN OPTICAL or COAXIAL jacks. Using other jacks may result in intermittent sound.

5.1CH Input Hookups

Although this receiver incorporates a multi channel decoder, it is also equipped with 5.1CH INPUT jacks. These connections allow you to enjoy multichannel software encoded in formats other than Dolby Digital (AC-3) and DTS. If your DVD player is equipped with 5.1CH OUTPUT jacks, you can connect them directly to this unit to enjoy the sound of the DVD player's multi channel decoder. Alternatively, the 5.1CH INPUT jacks can be used to connect an external multi channel decoder. To fully enjoy multi channel surround sound, you will need five speakers (two front speakers, two rear speakers, and a center speaker) and a sub woofer. Refer to the instruction manual supplied with your DVD player, multi channel decoder, etc., for details on the 5.1 channel input hookups.

Required cords

Audio cords (not supplied)

Two for the 5.1CH INPUT FRONT and REAR jacks

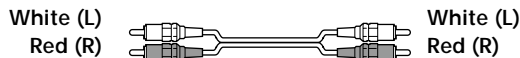

Monaural audio cords (not supplied)

Two for the 5.1CH INPUT CENTER and SUB WOOFER jacks

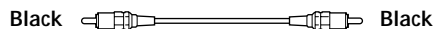

Video cord (not supplied)

One for the DVD/LD VIDEO IN jacks (etc.)

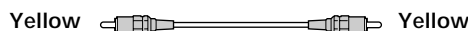

Note

When using the connections described below, adjust the level of your surround speakers and sub woofer from the DVD player or multichannel decoder.

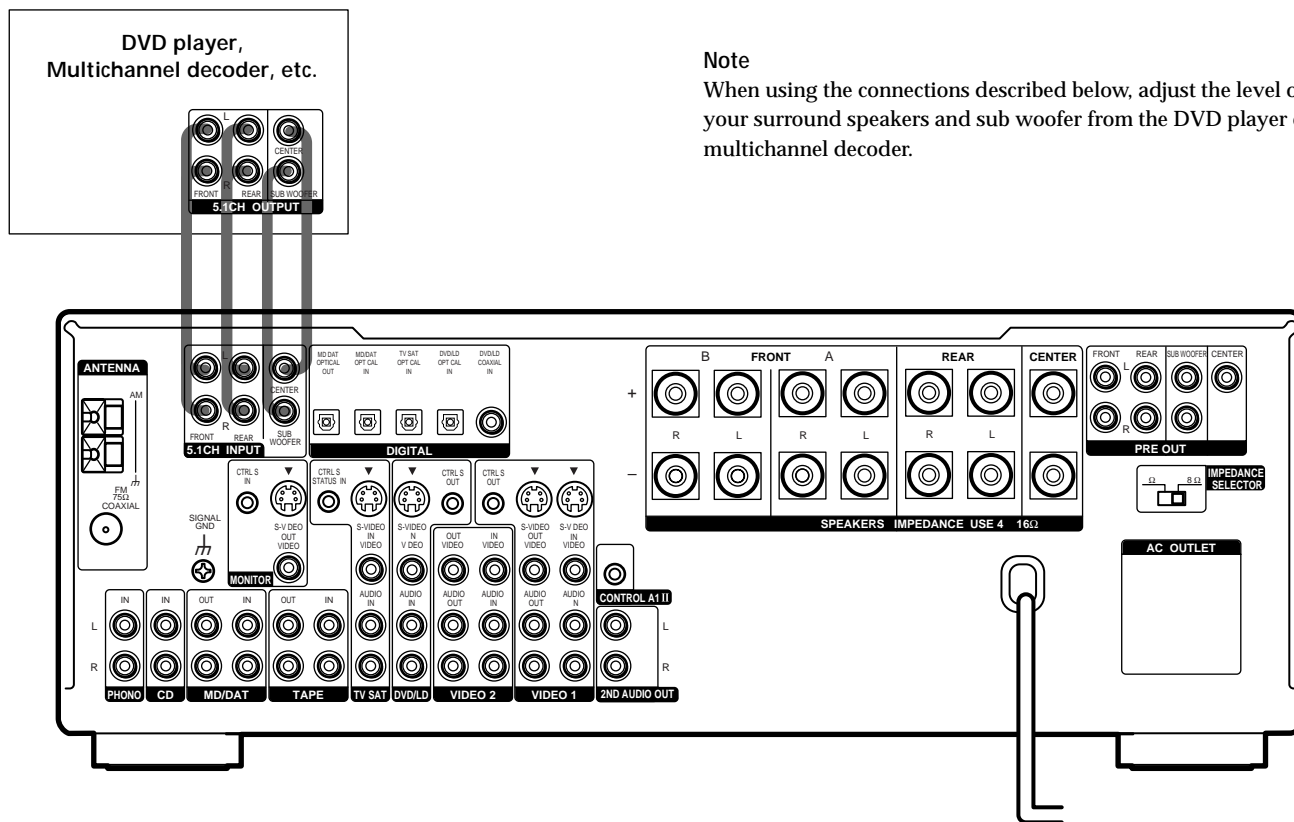

Example of a DVD player hookup using the 5.1CH INPUT jacks

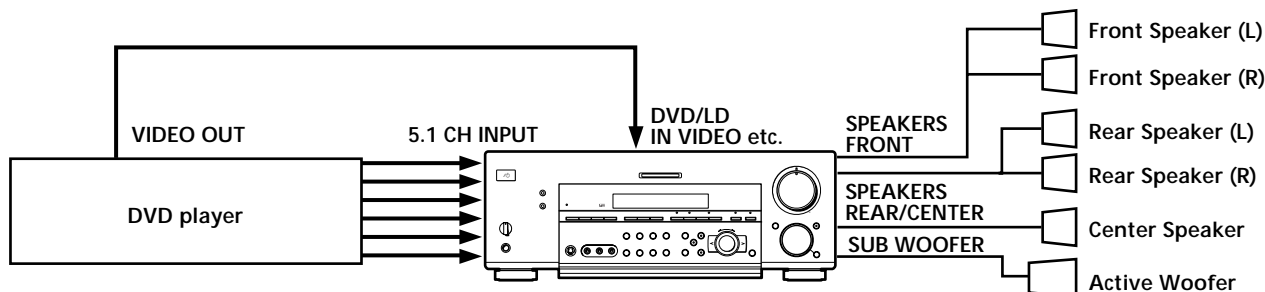

Note

See page 16 for details on speaker system hookup.

Other Hookups

Required cords

Audio cords (not supplied)

When connecting a cord, be sure to match the color-coded pins to the appropriate jacks on the components.



Audio/video/control S connecting cord (1)**

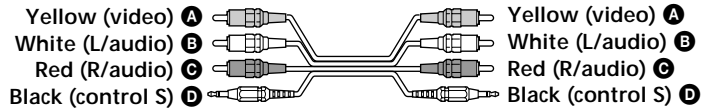

Control S connecting cord (1)**

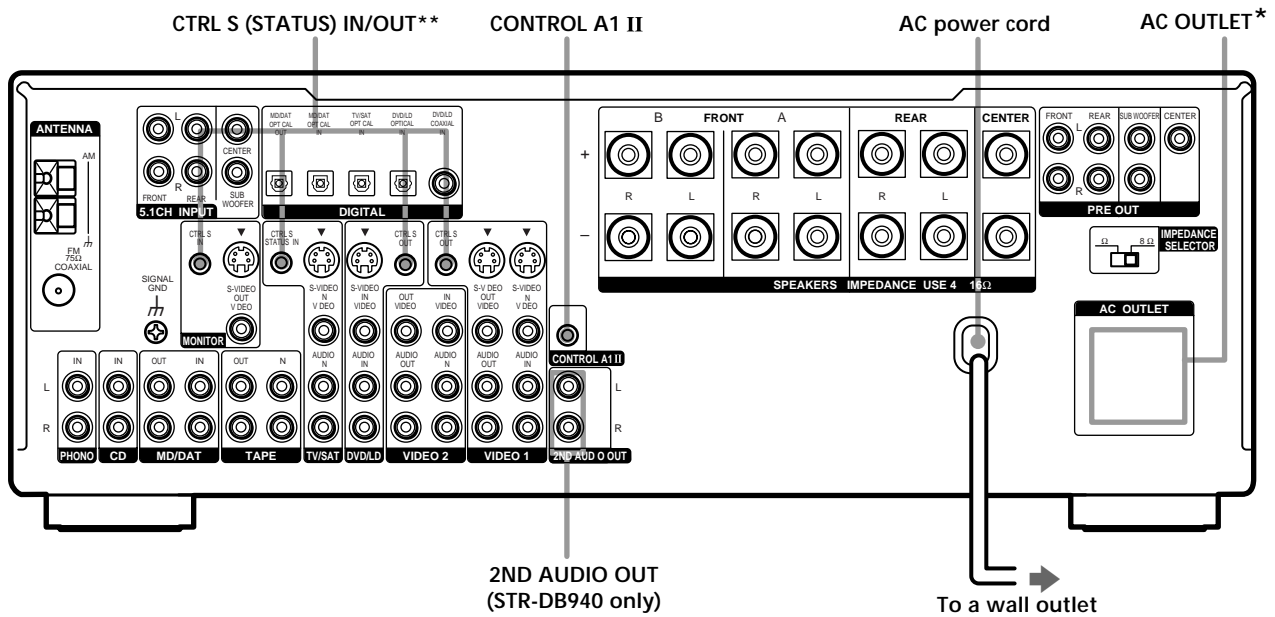

* The configuration, shape, and number of AC outlets on the rear panel varies according to the model and country to which the receiver is shipped.
** Models of area code U, CA only.

Example of a sub room hookup using the 2ND AUDIO OUT jacks (STR-DB940 only)

You can use the 2ND AUDIO OUT jacks to output the audio signal of the selected component to a stereo amplifier located in another room. Use MODE and FUNCTION (4) on pages 26 and 27) to switch the audio signal output to the sub room.

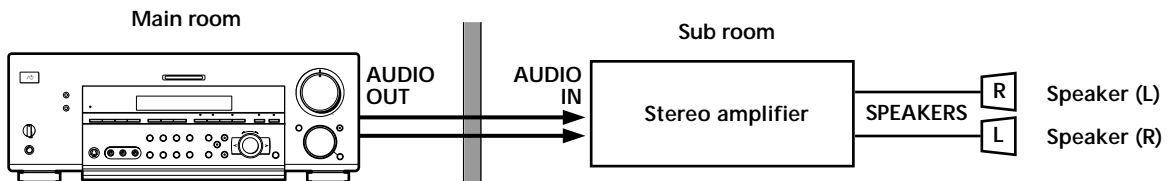

Note
This function is not available when 5.1CH INPUT is selected.

S-LINK CONTROL S hookup (Models of area code U,CA only)

If you have a S-LINK CONTROL S-compatible Sony TV, satellite tuner, monitor, DVD player or VCR, use an audio/video/control S connecting cord (supplied) or a control S connecting cord (supplied) to connect the CTRL S (STATUS) IN (for TV, satellite tuner, or monitor) or OUT (for VCR, etc.) jack on the receiver to the appropriate S-LINK jack on the respective component. Refer to the operating instructions supplied with your TV, satellite tuner, monitor, VCR, etc., for details.

The following illustration is an example of S-LINK CONTROL S hookups between the receiver, a TV, a VCR, and a DVD player. When your TV is connected to the receiver as shown below, the TV input mode will change to video input whenever you turn on the receiver. When you connect the receiver as shown below, input mode of the receiver changes to VIDEO 1 or DVD/LD whenever you play your VCR or DVD.

The following connections also change the input mode of the receiver to TV whenever you operate your TV.

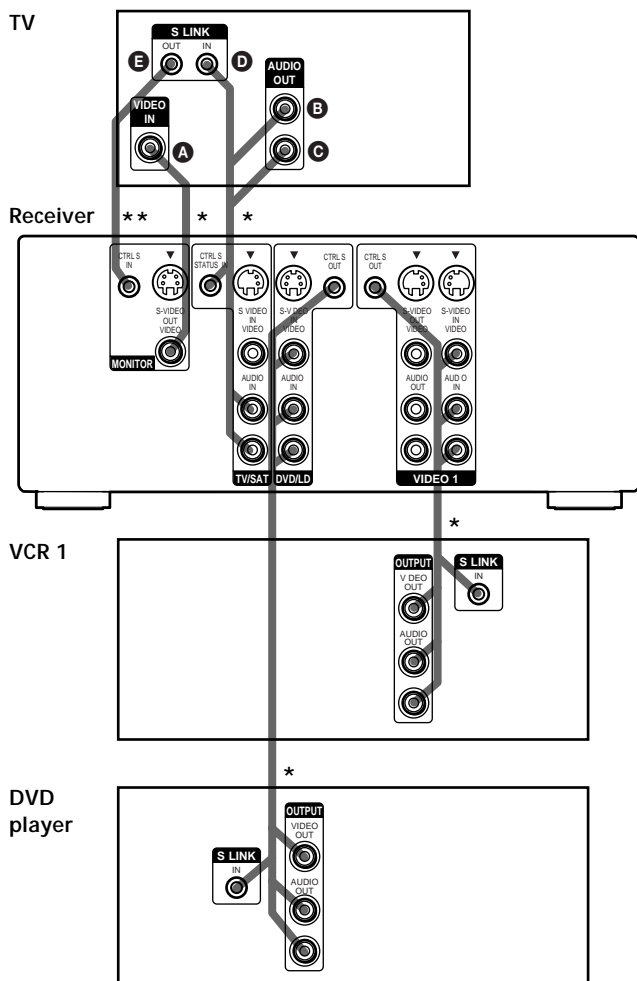

* Audio/video/control S connecting cord (Pull the video cord away from the supplied audio/video/control S cable for connection A.)

** Control S connecting cord

Note

Refer to the instructions supplied with your TV for details regarding the operations you can control from your TV.

CONTROL A1 II hookup

• If you have a CONTROL A1 II compatible Sony CD player, tape deck, or MD deck

Use a CONTROL A1 cord (not supplied) to connect the CONTROL A1 II jack on the CD player, tape deck, or MD deck to the CONTROL A1 II jack on the receiver. Refer to "CONTROL A1 II Control System" on page 54 and the operating instructions supplied with your CD player, tape deck, or MD deck for details.

Note

If you make CONTROL A1 II connections from the receiver to an MD deck that is also connected to a computer, do not operate the receiver while using the "Sony MD Editor" software. This may cause a malfunction.

• If you have a Sony CD changer with a COMMAND MODE selector

If your CD changer's COMMAND MODE selector can be set to CD 1, CD 2, or CD 3, be sure to set the command mode to "CD 1" and connect the changer to the CD jacks on the receiver.

If, however, you have a Sony CD changer with VIDEO OUT jacks, set the command mode to "CD 2" and connect the changer to the VIDEO 2 jacks on the receiver.

Connecting the AC power cord

Before connecting the AC power cord of this receiver to a wall outlet:

- Connect the speaker system to the receiver (see page 16).
- Turn the MASTER VOLUME control to the leftmost position (0).

Connect the AC power cord(s) of your audio/video components to a wall outlet.

If you connect other audio/video components to the AC OUTLET(s) on the receiver, the receiver will supply power to the connected component(s), allowing you to turn the whole system on or off when you turn the receiver on or off.

Caution

Make sure that the total power consumption of the component(s) connected to the receiver's AC OUTLET(s) does not exceed the wattage stated on the rear panel. Do not connect high-wattage electrical home appliances such as electric irons, fans, or TVs to this outlet.

Note

If the AC power cord is disconnected for about two weeks, the receiver's entire memory will be cleared and the demonstration will start.

Hooking Up and Setting Up the Speaker System

This chapter describes how to hook up your speaker system to the receiver, how to position each speaker, and how to set up your speakers to enjoy multi channel surround sound.

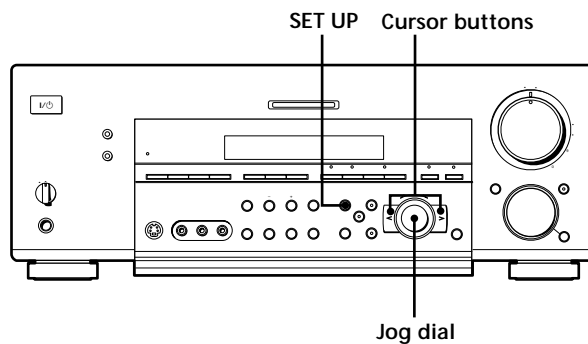

Brief descriptions of buttons and control used to set up the speaker system

SET UP button: Press to enter the setup mode when specifying speaker types and distances.

Cursor buttons (</>): Use to select parameters after pressing the SET UP button.

Jog dial: Use to adjust the setting of each parameter.

Speaker System Hookup

Required cords

Speaker cords (not supplied)

One for each front, rear, and center speaker



Monaural audio cord (not supplied)

One for an active sub woofer

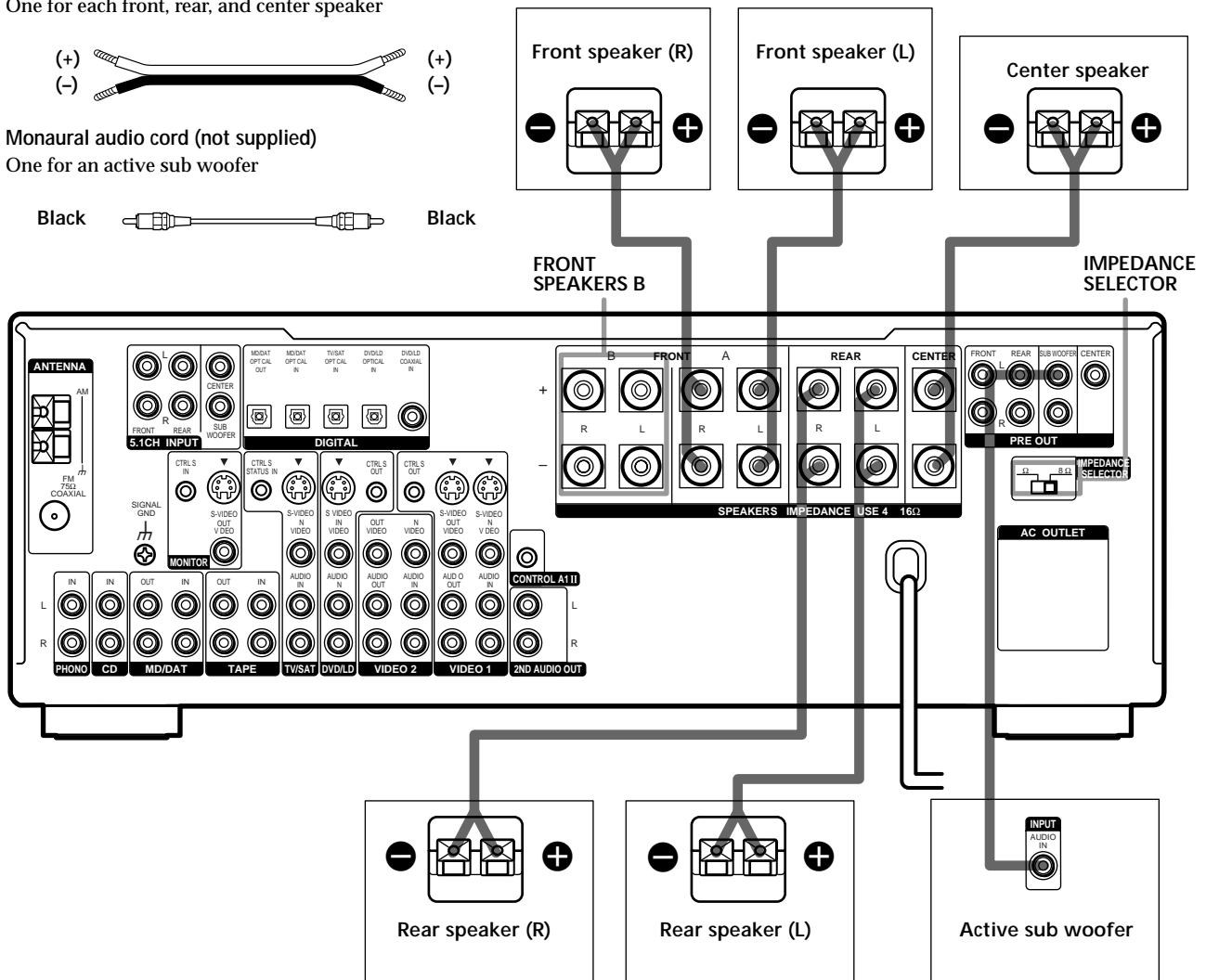

Terminals for connecting the speakers

Connect the	To the
Front speakers (8 or 4* ohm)	SPEAKERS FRONT A terminals
Additional pair of front speakers (8 or 4* ohm)	SPEAKERS FRONT B terminals
Rear speakers (8 or 4* ohm)	SPEAKERS REAR terminals
Center speaker (8 or 4* ohm)	SPEAKERS CENTER terminals
Active sub woofer	SUB WOOFER PRE OUT**

* See "Speaker impedance" on the next page.

** You can connect an active sub woofer to either of the two jacks. The remaining jack can be used to connect a second active sub woofer.



To connect certain speakers to another amplifier Use the PRE OUT jacks. The same signal is output from both the SPEAKERS jacks and the PRE OUT jacks. For example, if you want to connect just the front speakers to another amplifier, connect that amplifier to the PRE OUT FRONT L and R jacks.

Notes on speaker system hookup

- Twist the stripped ends of the speaker cords about 2/3 inch (10 mm). Be sure to match the speaker cord to the appropriate terminal on the components: + to + and - to -. If the cords are reversed, the sound will be distorted and will lack bass.
- If you use front speakers with low maximum input rating, adjust the volume carefully to avoid excessive output on the speakers.

To avoid short-circuiting the speakers

Short-circuiting of the speakers may damage the receiver. To prevent this, make sure to take the following precautions when connecting the speakers.

Make sure the stripped ends of each speaker cord do not touch another speaker terminal or the stripped end of another speaker cord.

Examples of poor conditions of the speaker cord

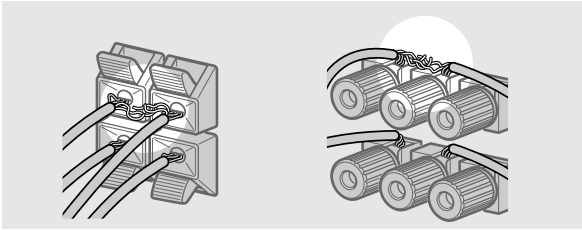

Stripped speaker cord is touching another speaker terminal.

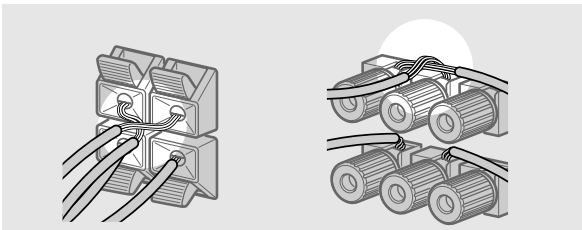

Stripped cords are touching each other due to excessive removal of insulation.

After connecting all the components, speakers, and AC power cord, output a test tone to check that all the speakers are connected correctly. For details on outputting a test tone, see page 22.

If no sound is heard from a speaker while outputting a test tone or a test tone is output from a speaker other than the one whose name is currently displayed on the receiver, the speaker may be short-circuited. If this happens, check the speaker connection again.

Speaker impedance

To enjoy multi channel surround, connect front, center, and rear speakers with a nominal impedance of 8 ohms or higher, and set the speaker IMPEDANCE SELECTOR to “8Ω.” Check the instruction manual supplied with your speakers if you’re not sure of their impedance. (This information is usually printed on a label on the back of the speaker.)

You may connect a pair of speakers with a nominal impedance between 4 and 8 ohms to all of the speaker terminals. However, even if one speaker within this range is connected, set the IMPEDANCE SELECTOR to “4Ω”.

Note

Be sure to connect front speakers with a nominal impedance of 8 ohms or higher if you want to select both sets (A+B) of front speakers (see page 30). In this case, set the IMPEDANCE SELECTOR to “4Ω”.

Performing Initial Setup Operations

Once you have hooked up the speakers and turned on the power, clear the receiver's memory. Then specify the speaker parameters (size, position, etc.) and perform any other initial setup operations necessary for your system.

Before turning on the receiver

Make sure that you have:

- Turned MASTER VOLUME to the leftmost position (0).
- Selected the appropriate front speakers (see "[27] SPEAKERS selector" on page 30).

Clearing the receiver's memory

Before using your receiver for the first time, or when you want to clear the receiver's memory, do the following. This procedure is not necessary if the demonstration activates when you turn the power on.

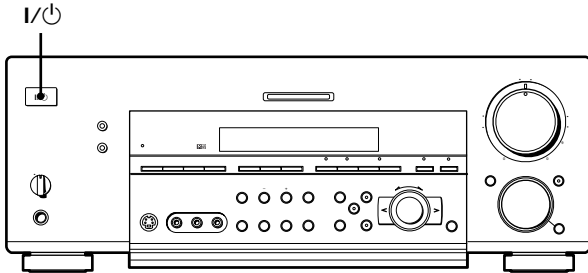

1 Turn off the receiver.

2 Hold down I/⏻ for 5 seconds.

The currently selected function, followed by the demonstration message appears in the display. All of the following items are reset or cleared:

- All preset stations are reset or cleared.
- All sound field parameters are reset to their factory settings.
- All index names (of preset stations and program sources) are cleared.
- All adjustments made with the SET UP button are reset to their factory settings.
- The sound field memorized for each program source and preset stations are cleared.

Performing initial setup operations

Before using your receiver for the first time, use the SET UP button to adjust the setup parameters so that they correspond to your system. You can adjust the following items. For details on how to make adjustments, see the page in parenthesis.

- Speaker size and placement (pages 19~22).
- Speaker distance (page 19).
- Whether other components will turn on or off automatically via the CONTROL A1 II control system (page 53).
- Whether the display turns off or not when you press DIMMER (page 54).
- STR-DB940 only:
 - 2 way remote control system operation (page 53).
 - Selecting the color of the on-screen display (page 54).
 - Select the TV color system of the monitor (except for models of area U, CA) (page 54).

Demonstration Mode

The demonstration will activate the first time you turn on the power. When the demonstration starts, the following message appears in the display twice:

"Now Demonstration Mode!! To finish the demonstration, please push POWER KEY while this message appears in the display. Thank you!"

To cancel the demonstration

Press I/⏻ to turn the receiver off during the previous message. The next time you turn the receiver on, the demonstration will not appear.

To view the demonstration

Hold down SET UP and press I/⏻ to turn on the power.

Note

Running the demonstration will clear the receiver's memory. For details on what will be cleared, see "Clearing the receiver's memory" on this page.

Multi Channel Surround Setup

For the best possible surround sound all speakers should be the same distance from the listening position (A). However, this unit lets you to place the center speaker up to 5 feet (1.5 meters) closer (B) and the rear speakers up to 15 feet (4.5 meters) closer (C) to the listening position. The front speakers can be placed from 3 to 40 feet (1.0 to 12.0 meters) from the listening position (A).

You can place the rear speakers either behind you or to the side, depending on the shape of your room (etc.).

When placing rear speakers to your side

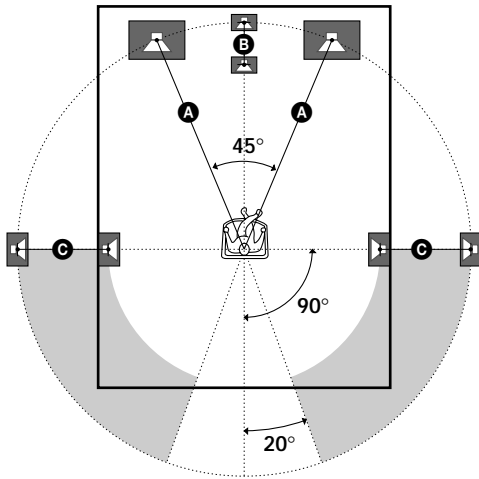

When placing rear speakers behind you

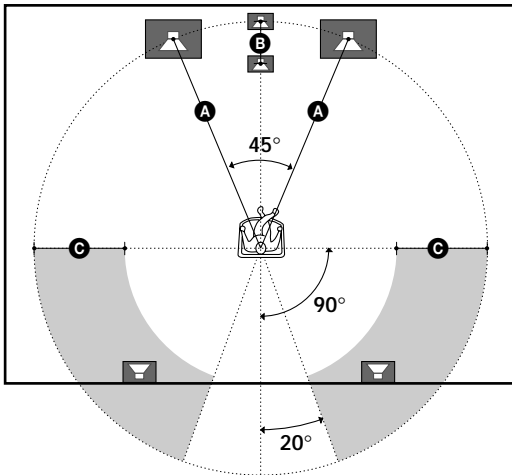

Note

Do not place the center speaker farther away from the listening position than the front speakers.

Specifying the speaker parameters

- 1 Press I/⏻ to turn on the receiver.
- 2 Press SET UP.
- 3 Press the cursor buttons (< or >) to select the parameter you want to adjust.
- 4 Turn the jog dial to select the setting you desire. The setting is entered automatically.
- 5 Repeat steps 3 and 4 until you have set all of the parameters that follow.

■ **Front speaker size (FRONT)**

Initial setting : LARGE

- If you connect large speakers that will effectively reproduce bass frequencies, select "LARGE". Normally, select "LARGE".
- If the sound is distorted, or you feel a lack of surround effects when using multi channel surround sound, select "SMALL" to activate the bass redirection circuitry and output the front channel bass frequencies from the sub woofer.
- When the front speaker is set to "SMALL", the center and rear speakers are also automatically set to "SMALL" (unless previously set to "NO").

■ Center speaker size (CENTER)

Initial setting : LARGE

- If you connect a large speaker that will effectively reproduce bass frequencies, select "LARGE". Normally, select "LARGE". However, if the front speakers are set to "SMALL", you cannot set the center speaker to "LARGE".
- If the sound is distorted, or you feel a lack of surround effects when using multi channel surround sound, select "SMALL" to activate the bass redirection circuitry and output the center channel bass frequencies from the front speakers (if set to "LARGE") or sub woofer. ^{*1}
- If you do not connect a center speaker, select "NO". The sound of the center channel will be output from the front speakers. ^{*2}

■ Rear speaker size (REAR)

Initial setting : LARGE

- If you connect large speakers that will effectively reproduce bass frequencies, select "LARGE". Normally, select "LARGE". However, if the front speakers are set to "SMALL", you cannot set the rear speakers to "LARGE".
- If the sound is distorted, or you feel a lack of surround effects when using multi channel surround sound, select "SMALL" to activate the bass redirection circuitry and output the rear channel bass frequencies from the sub woofer or other "LARGE" speakers.
- If you do not connect rear speakers, select "NO". ^{*3}

 *1~*3 correspond to the following Dolby Pro Logic modes

- *1 NORMAL
- *2 PHANTOM
- *3 3 STEREO

About speaker sizes (LARGE and SMALL)

Internally, the LARGE and SMALL settings for each speaker determine whether or not the internal sound processor will cut the bass signal from that channel. When the bass is cut from a channel, the bass redirection circuitry sends the corresponding bass frequencies to the sub woofer or other "LARGE" speakers. However, since bass sounds have a certain amount of directionality, it best not to cut them, if possible. Therefore, even when using small speakers, you can set them to "LARGE" if you want to output the bass frequencies from that speaker. On the other hand, if you are using a large speaker, but prefer not to have bass frequencies output from that speaker, set it to "SMALL".

If the overall sound level is lower than you prefer, set all speakers to "LARGE". If there is not enough bass, you can use the equalizer to boost the bass levels. To adjust the equalizer, see page 40.

■ Rear speaker position (REAR PLACE) *

Initial setting : BEHIND

This parameter lets you specify the location of your rear speakers for proper implementation of the Digital Cinema Sound surround modes in the "VIRTUAL" sound fields. Refer to the illustration below.

- Select "SIDE" if the location of your rear speakers corresponds to section **A**.
- Select "MIDDLE" if the location of your rear speakers corresponds to section **B**.
- Select "BEHIND" if the location of your rear speakers corresponds to section **C**.

This setting only effects the surround modes in the "VIRTUAL" sound fields.

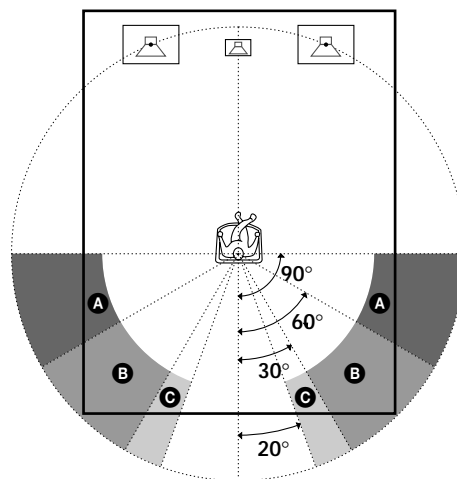

■ Rear speaker height (REAR HEIGHT)*

Initial setting : LOW

This parameter lets you specify the height of your rear speakers for proper implementation of the Digital Cinema Sound surround modes in the “VIRTUAL” sound fields. Refer to the illustration below.

- Select “LOW” if the location of your rear speakers corresponds to section **A**.
- Select “HIGH” if the location of your rear speakers corresponds to section **B**.

This setting only effects the surround modes in the “VIRTUAL” sound fields.

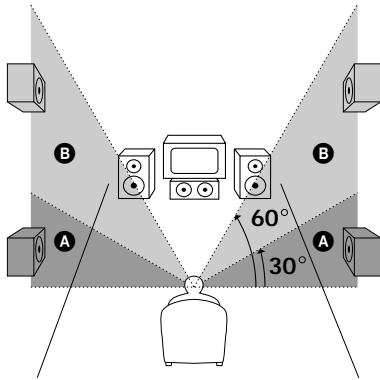

* These parameters are not available when “Rear speaker size (REAR)” is set to “NO”.

💡 About the rear speaker position (SIDE, MIDDLE, and BEHIND)

This setting is designed specifically for implementation of the Digital Cinema Sound modes in the “VIRTUAL” sound fields. With the Digital Cinema Sound modes, speaker position is not as critical as other modes. All of the modes in the “VIRTUAL” sound fields were designed under the premise that the rear speaker would be located behind the listening position, but presentation remains fairly consistent even with the rear speakers positioned at a rather wide angle. However, if the speakers are pointing toward the listener from the immediate left and right of the listening position, the “VIRTUAL” sound fields will not be effective unless the rear speaker position parameter is set to “SIDE”.

Nevertheless, each listening environment has many variables, like wall reflections, and you may obtain better results using “BEHIND” or “MIDDLE” if your speakers are located high above the listening position, even if they are to the immediate left and right.

Therefore, although it may result in a setting contrary to the “Rear speaker position” explanation, we recommend that you playback multi channel surround encoded software and listen to the effect each setting has on your listening environment. Choose the setting that provides a good sense of spaciousness and that best succeeds in forming a cohesive space between the surround sound from the rear speakers and the sound of the front speakers. If you are not sure which sounds best, select “BEHIND” and then use the speaker distance parameter and speaker level adjustments to obtain proper balance.

■ Sub woofer selection (SUB WOOFER)

Initial setting : YES

- If you connect a sub woofer, select “YES”.
- If you do not connect a sub woofer, select “NO”. This activates the bass redirection circuitry and outputs the LFE signals from other speakers.
- In order to take full advantage of the Dolby Digital (AC-3) bass redirection circuitry, we recommend setting the sub woofer’s cut off frequency as high as possible.

■ Front speaker distance (FRONT)

Initial setting : 16 feet* (5.0 meter)

Set the distance from your listening position to the front (left or right) speaker (**A** on page 19).

- Front speaker distance can be set in 1 foot* (0.1 meter) steps from 3 to 40 feet* (1.0 to 12.0 meters).
- If both speakers are not placed an equal distance from your listening position, set the distance to the closest speaker.

* Models of area code U, CA only.

■ Center speaker distance (CENTER)

Initial setting : 16 feet* (5.0 meter)

Set the distance from your listening position to the center speaker.

- Center speaker distance can be set in 1 foot* (0.1 meter) steps from a distance equal to the front speaker distance (**A** on page 19) to a distance 5 feet* (1.5 meters) closer to your listening position (**E** on page 19).
- Do not place the center speaker farther away from your listening position than the front speakers.

* Models of area code U, CA only.

■ Rear speaker distance (REAR)

Initial setting : 11 feet* (3.5 meter)

Set the distance from your listening position to the rear (left or right) speaker.

- Rear speaker distance can be set in 1 foot* (0.1 meter) steps from a distance equal to the front speaker distance (**A** on page 19) to a distance 15 feet* (4.5 meters) closer to your listening position (**C** on page 19).
- Do not place the rear speakers farther away from your listening position than the front speakers.
- If both speakers are not placed an equal distance from your listening position, set the distance to the closest speaker.

* Models of area code U, CA only.

Multi Channel Surround Setup

About speaker distances

This unit allows you to input the speaker position in terms of distance. However, it is not possible to set the center speaker further than the front speakers. Also, the center speaker cannot be set more than 5 feet* (1.5 meters) closer than the front speakers.

Likewise, the rear speakers can not be set farther away from the listening position than the front speakers. And they can be no more than 15 feet* (4.5 meters) closer.

This is because incorrect speaker placement is not conducive to the enjoyment of surround sound.

Please note that, setting the speaker distance closer than the actual location of the speakers will cause a delay in the output of the sound from that speaker. In other words, the speaker will sound like it is farther away.

For example, setting the center speaker distance 3~6 feet* (1~2 m) closer than the actual speaker position will create a fairly realistic sensation of being "inside" the screen. If you cannot obtain a satisfactory surround effect because the rear speakers are too close, setting the rear speaker distance closer (shorter) than the actual distance will create a larger soundstage.

Adjusting these parameter while listening to the sound often results in much better surround sound. Give it a try!

* Models of area code U, CA only.

■ Distance unit (DIST. UNIT)

Initial setting : feet* (meter)

Lets you select either feet or meters as the unit of measure for setting distances. 1 foot corresponds to a 1 ms difference.

* Models of area code U, CA only.

■ Front speaker crossover frequency (FRONT SP >)

Initial setting : 120 Hz

Lets you adjust the front speaker bass crossover frequency when the front speakers are set to "SMALL". The frequency can be adjusted in 30 Hz steps from 60 Hz to 180 Hz.

■ Center speaker crossover frequency (CENTER SP >)

Initial setting : 120 Hz

Lets you to adjust the center speaker bass crossover frequency when the center speaker is set to "SMALL". The frequency can be adjusted in 30 Hz steps from 60 Hz to 180 Hz.

■ Rear speaker crossover frequency (REAR SP >)

Initial setting : 120 Hz

Lets you adjust the rear speaker bass crossover frequency when the rear speakers are set to "SMALL". The frequency can be adjusted in 30 Hz steps from 60 Hz to 180 Hz.

Adjusting the speaker volume

Use the remote while seated in your listening position to adjust the volume of each speaker.

Note

This unit incorporates a new test tone with a frequency centered at 800 Hz for easier speaker volume adjustment.

- 1 Press **I/⏻** to turn on the receiver.
- 2 Press **TEST TONE** on the front panel (except for models of area code CED) or on the supplied remote.
You will hear the test tone from each speaker in sequence.
- 3 Adjust the volume level so that the volume of the test tone from each speaker sounds the same when you are in your main listening position.
 - To adjust the balance of the front right and front left speakers, use the front balance parameter in the LEVEL menu (see page 39).
 - To adjust the balance of the rear right and rear left speakers, use the rear balance parameter in the LEVEL menu (see page 39).
 - To adjust the volume level of the center speaker, press the LEVEL CENTER +/- buttons on the remote.
 - To adjust the volume level of the rear speakers, press the LEVEL REAR +/- buttons on the remote.
- 4 Press **TEST TONE** again to turn off the test tone.

Note

The test tone cannot be output when the receiver is set to 5.1CH INPUT.

 You can adjust the volume level of all speakers at the same time
Rotate MASTER VOLUME on the main unit or press MASTER VOLUME +/- on the remote.

Notes

- The front balance, rear balance, center level, and rear level are shown in the display during adjustment.
- Although these adjustments can also be made via the front panel using the LEVEL menu (when the test tone is output, the receiver switches to the LEVEL menu automatically), we recommend you follow the procedure described above and adjust the speaker levels from your listening position using the remote control.

Before You Use Your Receiver

Before turning on the receiver

Make sure that you have:

- Turned MASTER VOLUME to the leftmost position (0).
- Selected the appropriate front speakers (see “[27](#) SPEAKERS selector” on page 30).

Checking the connections

After connecting all of your components to the receiver, do the following to verify that the connections were made correctly.

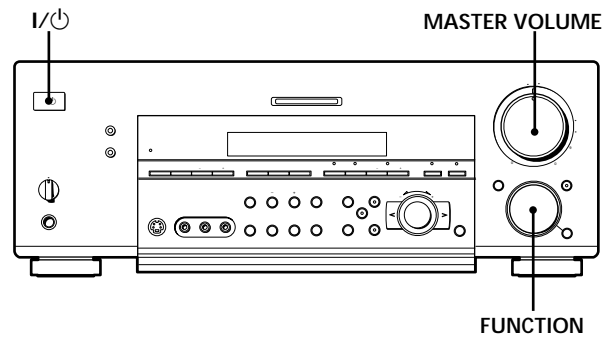

- 1** Press I/Power to turn on the receiver.
- 2** Rotate FUNCTION to select a component (program source) that you connected (e.g., CD player or tape deck).
- 3** Turn on the component and start playing it.
- 4** Rotate MASTER VOLUME to turn up the volume.

If you do not obtain normal sound output after performing this procedure, look for the reason in the checklist on the following page and take the appropriate measures to correct the problem.

Before You Use Your Receiver

There is no sound no matter which component is selected.

- ➔ Check that both the receiver and all components are turned on.
- ➔ Check that the MASTER VOLUME control is not set at 0.
- ➔ Check that the SPEAKERS selector is not set to OFF or to a position for front speakers that are not connected to the receiver (see “[27](#) SPEAKERS selector” on page 30).
- ➔ Check that all speaker cords are connected correctly.
- ➔ Press the MUTING button to turn off the indicator on the button.

There's no sound from a specific component.

- ➔ Check that the component is connected correctly to the audio input jacks for that component.
- ➔ Check that the cord(s) used for the connection is (are) fully inserted into the jacks on both the receiver and the component.

No sound is heard from one of the front speakers.

- ➔ Connect a pair of headphones to the PHONES jack and set the SPEAKERS selector to OFF to verify that sound is output from the headphones (see “[27](#) SPEAKERS selector” and “PHONES jack” on page 30).
If only one channel is output from the headphones, the component may not be connected to the receiver correctly. Check that all the cords are fully inserted into the jacks on both the receiver and the component.
If both channels are output from the headphones, the front speaker may not be connected to the receiver correctly. Check the connection of the front speaker which is not outputting any sound.

If you encounter a problem that is not included above, see “Troubleshooting” on page 56.

Location of Parts and Basic Operations

This chapter provides information about the locations and functions of the buttons and controls on the front panel. It also explains basic operations.

Front Panel Parts Description

1 I/⏻ switch

Press to turn the receiver on and off.

- Before you turn on the receiver, make sure that you have turned the MASTER VOLUME control to the leftmost position to avoid damaging your speakers.

2 MASTER VOLUME control

After turning on the component you selected, rotate to adjust the volume.

3 MUTING button

Press to mute the sound. The indicator on the button lights up when the sound is muted.

4 FUNCTION control

Rotate to select the component you want to use.

To select	Rotate to light
VCR	VIDEO 1 or VIDEO 2
Camcorder or video game	VIDEO 3
DVD or LD player	DVD/LD
TV or satellite tuner	TV/SAT
Tape deck MD or Tape deck	TAPE (STR-DB940) MD/TAPE (STR-DB840)
MD or DAT deck	MD/DAT (STR-DB940 only)
CD player	CD
Built in tuner	TUNER
Turntable	PHONO

After selecting the component, turn on the component you selected and play the program source.

- After selecting VCR, camcorder, video game, DVD player, or LD player, turn on the TV and set the TV's video input to match the component you selected.

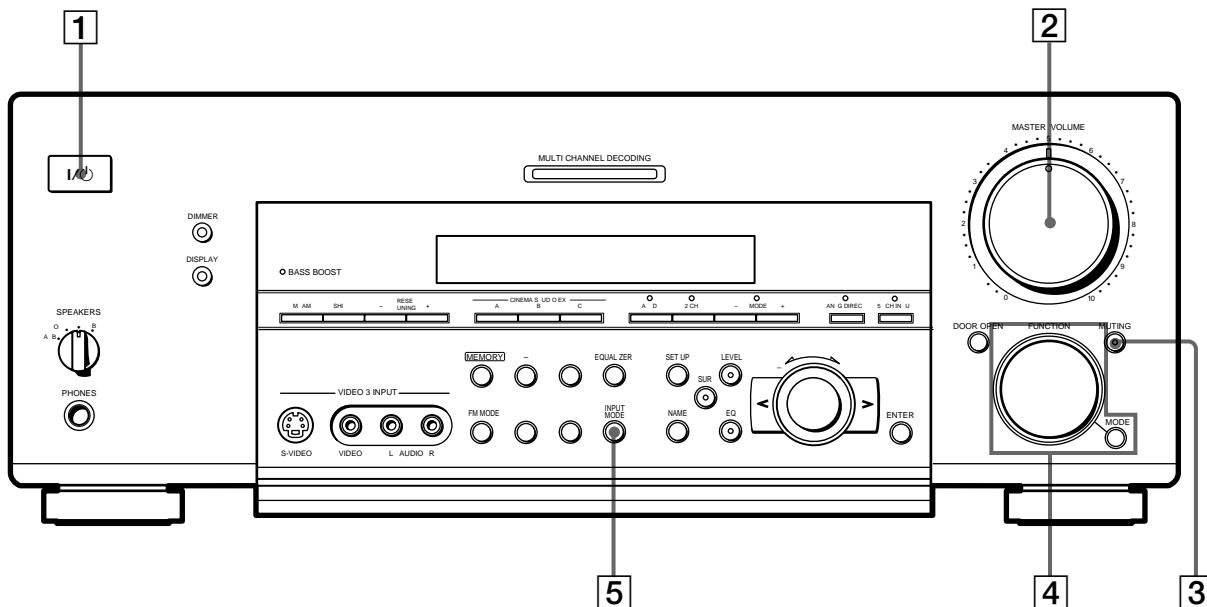

MODE button

Press to select and play another video/audio source in combination with the selected component. Each time you press the button, the display changes as follows:

Standard display (When 5.1CH INPUT is not selected)

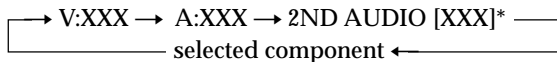

When 5.1CH INPUT is selected



* STR-DB940 only.

Press MODE to display	And rotate FUNCTION to select
V:XXX	Any video source to enjoy with the audio from the selected component
A:XXX	Any audio source to enjoy with the video from the selected component
2ND AUDIO [XXX] (STR-DB940 only)	An audio source (except PHONO) to enjoy in your sub room. "SOURCE" selects the same program source as the main FUNCTION control**

** Even if 2ND AUDIO [SOURCE] is selected, no sound is output when the receiver is set to 5.1CH INPUT. Only signals from components connected to the analog inputs are output through the 2ND AUDIO jacks. No signals are output from components connected to only the digital inputs.

Function indicators

Normally, the indicator above the selected function lights orange. However, when MODE is used to select a different video (V:XXX) or audio (A:XXX) source, the video function lights green and the audio function lights orange. This also occurs when you select audio components (like CD).

5 INPUT MODE button

Press to select the input mode for your digital components (DVD/LD, TV/SAT, and MD/DAT (STR-DB940) or MD/TAPE (STR-DB840)).

Each press switches the input mode of the currently selected component.

Select	To
AUTO	Give priority to digital signals when there are both digital and analog connections. If there are no digital signals, analog is selected
DIGITAL (OPTICAL)	Specify the digital audio signals input to the DIGITAL OPTICAL input jacks
DIGITAL (COAXIAL)	Specify the digital audio signals input to the DIGITAL COAXIAL input jacks (DVD/LD only)
ANALOG	Specify the analog audio signals input to the AUDIO IN (L and R) jacks

Front Panel Parts Description

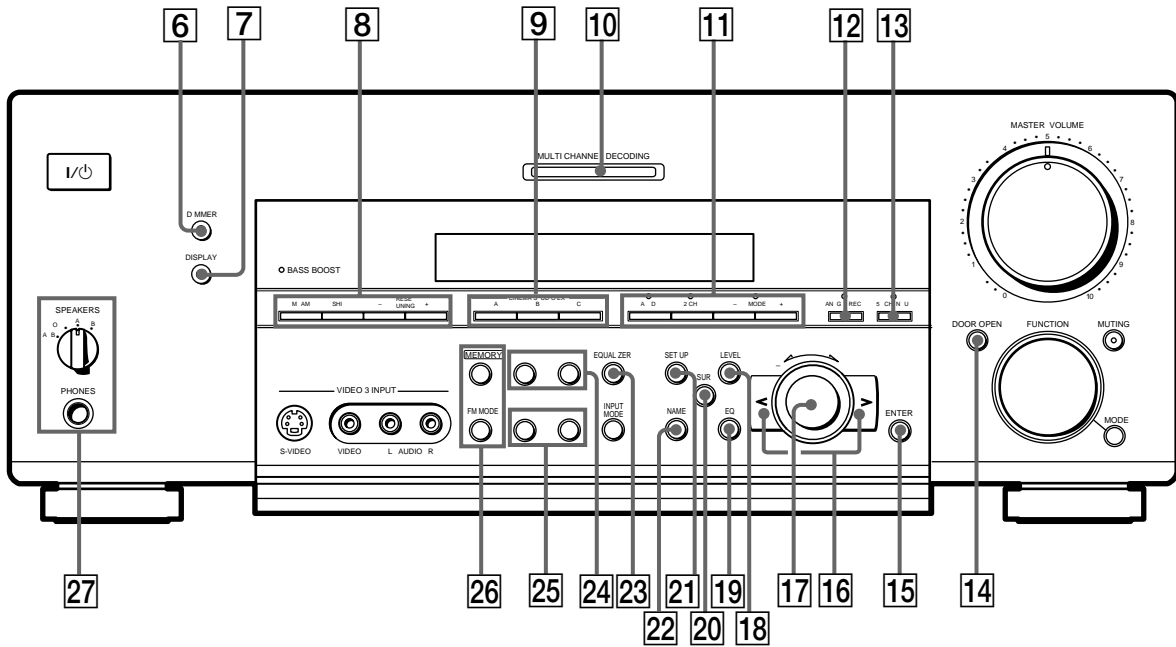

6 DIMMER button

Press repeatedly to adjust the brightness of the display. When you want to turn off the display, set in the "DIMM. RANGE" parameter in the SET UP menu (page 54).

7 DISPLAY button

Press repeatedly to change the information on the display window as follows:

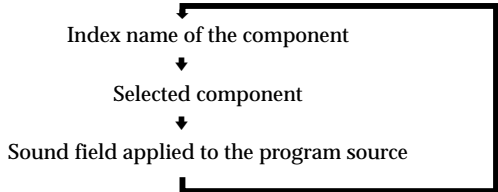

When the tuner is selected

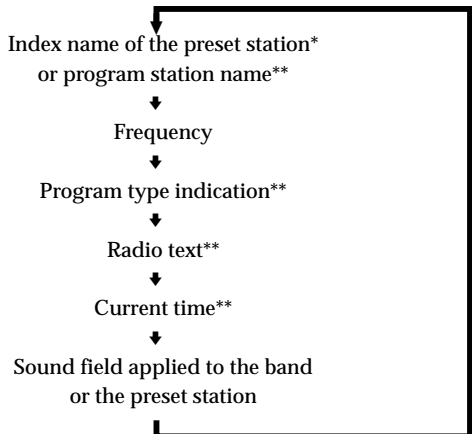

* Index name appears only when you have assigned one to the component or preset station (see page 51). Index name does not appear when only blank spaces have been entered, or it is the same as the function button.

** These indications appear only during RDS reception. (Models of area code CED only. See page 47).

8 The following buttons operate the built-in tuner. For details, see "Receiving Broadcasts" starting from page 43.

FM/AM button
Selects the FM or AM band.

SHIFT button
Selects a memory page for preset stations.

PRESET TUNING +/- buttons
Scans all preset stations.

9 CINEMA STUDIO EX. A~C buttons
Press to select CINEMA STUDIO EX. A~C sound field. For details, see "CINEMA STUDIO EX. A~C" on page 33.

10 MULTI CHANNEL DECODING indicator
This indicator lights when the unit is decoding signals recorded in a multi channel format.

- 11 Use these buttons to enjoy surround sound. For details, see “Enjoying Surround Sound” starting from page 31.

A.F.D. button / indicator

Press to set the receiver to automatically detect the type of audio signal being input and perform proper decoding (if necessary). For details, see “AUTO FORMAT DECODING” on page 35.

2CH button / indicator

Press to output sound from only the front (left and right) speakers. For details, see “2 CHANNEL” on page 35.

MODE +/- buttons / indicator

Press repeatedly to select the sound field you desire. For details, see “Selecting a Sound Field” on page 32.

- Sound fields are not compatible with 96 kHz digital audio signals.

- 12 **ANLG DIRECT button**

Press to listen to an analog source without digital processing by the equalizer, sound field, etc. For details, see “ANALOG DIRECT” on page 35.

- 13 **5.1CH INPUT button**

Press to enjoy the audio source connected to the 5.1CH INPUT jacks. Press 5.1 CH again to return to the original function.

- When 5.1CH INPUT is selected, the equalizer, bass boost, and sound field effects do not function.

- 14 **DOOR OPEN button**

Press to open the door on the front panel.

- 15 **ENTER button**

Press to enter individual characters for the preset station and program source names.

- 16 **Cursor buttons (</>)**

Press to select various speaker level, surround, and equalizer parameters (etc.).

- 17 **Jog dial**

Turn to adjust the selected speaker level, surround, and equalizer parameters (etc.).

- 18 **LEVEL button**

Press to activate the speaker level parameters (page 39). The indicator on the button lights up and you can adjust the various speaker level parameters (front balance, rear balance, etc.).

- 19 **EQ button**

Press to activate the equalizer parameters (page 40). The indicator on the button lights up and you can adjust the various equalizer parameters.

- 20 **SUR button**

Press to activate the surround parameters (page 38). The indicator on the button lights up and you can adjust the various surround parameters (effect level, wall type, etc.).

- 21 **SET UP button**

Press to activate the setup mode, then use the cursor buttons (16) to select any of the following parameters. You can make various settings using the jog dial (17).

When you select	You can
Speaker setup	Specify the front, center, rear speaker sizes, the rear speaker position, and whether or not you are using a sub woofer (page 19).
Speaker Distance	Specify the front, center, and rear speaker distances and the unit of measurement (page 21).
Crossover frequency*	Specify the front, center, and rear speaker bass crossover frequency (page 22).
Auto Function	Specify whether or not Sony components connected via Control A1 cords will turn on or off when selected using the function buttons (page 53).
2 way remote (STR-DB940 only)	Turn on or off response to remote signals sent from the 2 way remote (page 53).
Color system (STR-DB940 of area codes other than U, CA)	Select the TV color system of the monitor.
OSD color (STR-DB940 only)	Specify the color of the on-screen display (page 54).
Dimmer Range	Specify the display to turn off when you press the DIMMER button several times (page 54).

* Only when the speaker is set to “SMALL” in the speaker setup parameter.

Front Panel Parts Description

22 NAME button

Press to activate the name function and enter names for preset stations and program sources (page 51).

23 EQUALIZER button

Press to turn the equalizer on or off. The EQ indicator in the display lights in the display when the equalizer is turned on.

When you adjust the equalizer using the EQ parameters (page 40), the settings are stored automatically and can be reproduced whenever you turn on the equalizer.

- The equalizer is not compatible with 96 kHz digital audio signals and during 5.1CH input.

24 The following buttons operate the built-in tuner. For details, see “Receiving Broadcasts” starting from page 43.

Models of area code CED

TUNING/PTY SELECT +/- buttons

Scans all the available radio stations.

Selects program types during PTY operations.

Models of other area codes

TUNING +/- buttons

Scans all the available radio stations.

25

Models of area code CED

The following buttons operate the built-in tuner. For details, see “Using the Radio Data System (RDS)” starting from page 47.

RDS EON button

Press to set the receiver to automatically switch to stations broadcasting traffic announcements, news, or information program. The EON button does not function during AM reception.

RDS PTY button

Press to scan stations by program type. The PTY button does not function during AM reception.

Models of other area codes

TEST TONE button

Press to output the test tone.

SLEEP button

Press to activate the sleep timer.

26 The following buttons operate the built-in tuner. For details, see “Receiving Broadcasts” starting from page 43.

MEMORY button

Press to memorize a preset station.

FM MODE button

If “STEREO” flashes in the display and the FM stereo reception is poor, press this button. You will not have the stereo effect but the sound is improved.

27 SPEAKERS selector

Set according to the front speakers you want to drive.

Set to	To select
A	The speakers connected to the FRONT SPEAKERS A terminals
B	The speakers connected to the FRONT SPEAKERS B terminals
A+B*	The speakers connected to both the FRONT SPEAKERS A and B terminals (parallel connection)
OFF	No speaker output

* Be sure to connect front speakers with a nominal impedance of 8 ohms or higher if you want to select both sets (A+B) of front speakers. In this case, set the IMPEDANCE SELECTOR to “4Ω”

PHONES jack

Connects headphones.

- To use the headphones, set the SPEAKERS selector to OFF to output sound to the headphones.
- To enjoy surround sound from the headphones, we recommend selecting the HEADPHONE THEATER sound field. Selecting other sound fields when the SPEAKERS selector is set to OFF automatically presents a 2 channel (stereo) downmix from the headphones.

Enjoying Surround Sound

This chapter describes how to set up the receiver to enjoy surround sound. You can enjoy multi channel surround when playing back software encoded with Dolby Digital or DTS.

You can take advantage of surround sound simply by selecting one of the receiver's pre-programmed sound modes. They bring the exciting and powerful sound of movie theaters and concert halls into your home. You can also customize the sound modes to obtain the sound you desire by changing the various surround parameters. The receiver contains a variety of different sound modes. The cinema sound modes are designed for use when playing back movie software (DVD, LD, etc.) encoded with multi channel surround sound or Dolby Pro Logic. In addition to decoding the surround sound, some of these modes also provide sound effects commonly found in movie theaters.

The virtual sound modes contain compelling applications of the Sony Digital Cinema Sound digital signal processing technology. They shift the sound away from the actual speaker locations to simulate the presence of several "virtual" speakers.

The music (etc.) sound modes are designed for use with standard audio sources and TV broadcasts. They add reverberation to the source signal to make you feel as if you were in a concert hall or stadium (etc.). Use these sound modes with two-channel sources like CD and stereo broadcasts of sports programs or musical concerts. For more information about the sound modes, see pages 33~35.

A.F.D.

The "Auto Format Decoding" sound mode presents the sound exactly as it was encoded, without adding any reverberation (etc.).

To fully enjoy surround sound, you must register the number and location of you speakers. See "Multi Channel Surround setup" starting on page 19 to set the speaker parameters before enjoying surround sound.

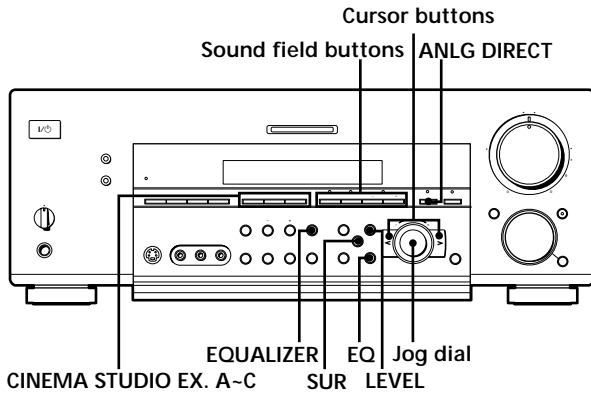

Brief descriptions of buttons used to enjoy surround sound

- LEVEL button:** Press to light and customize the level parameters.
- SUR button:** Press to light and customize the surround parameters in the current sound field.
- EQ button:** Press to light and customize the equalizer parameters in the current sound field.
- Cursor buttons (</>):** Use to select parameters after pressing the LEVEL, SUR, or EQ buttons.
- Jog dial:** Use to adjust parameters and select sound fields (etc.).
- A.F.D. button:** Press to set the receiver to automatically detect the type of audio signal being input and perform proper decoding (if necessary).
- 2CH button:** Press to output sound from only the front (left and right) speakers.
- MODE +/- button:** Press to select the sound field.
- CINEMA STUDIO EX. A~C buttons:** Press to select CINEMA STUDIO EX. A~C sound field.
- EQUALIZER button:** Turns the equalizer on or off.
- ANLG DIRECT button:** Press to input the analog signal without digital processing. When this function is on, the equalizer, bass boost and sound field (etc.) are turned off.

Selecting a Sound Field

You can enjoy surround sound simply by selecting one of the pre-programmed sound fields according to the program you want to listen to.

- 1** Press MODE +/- repeatedly to select the sound field you desire.

The current sound field is indicated in the display. See the table starting on page 33 for information on each sound field.

To turn the sound field off

Press A.F.D. or 2CH (page 35).

 The receiver memorizes the last sound field selected for each program source (Sound Field Link)

Whenever you select a program source, the sound field that was last applied is automatically applied again. For example, if you listen to CD with STADIUM as the sound field, change to a different program source, then return to CD, STADIUM will be applied again. With the tuner, sound fields are memorized separately for AM, FM, and all preset stations.

 You can identify the encoding format of program software by looking at its packaging

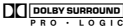
Dolby Digital discs are labeled with the  logo, and Dolby Surround encoded programs are labeled with the  logo.

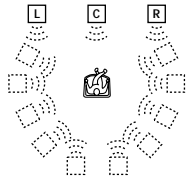
Sound field	Effect	Notes
NORMAL SURROUND	Software with multi channel surround audio signals is played according to the way it was recorded. Software with 2 channel audio signals, is decoded with Dolby Pro Logic to create surround effects.	
CINEMA STUDIO EX. A ¹⁾²⁾ (Press CINEMA STUDIO EX. A button)	Reproduces the sound characteristics of the Sony Pictures Entertainment “Cary Grant Theater” cinema production studio using the 3D sound imaging of V. MULTI DIMENSION (page 34) to create 5 sets of virtual speakers surrounding the listener from a single pair of actual rear speakers.	This is a standard mode, great for watching most any type of movie.
CINEMA STUDIO EX. B ¹⁾²⁾ (Press CINEMA STUDIO EX. B button)	Reproduces the sound characteristics of the Sony Pictures Entertainment “Kim Novak Theater” cinema production studio using the 3D sound imaging of V. MULTI DIMENSION (page 34) to create 5 sets of virtual speakers surrounding the listener from a single pair of actual rear speakers.	This mode is ideal for watching science-fiction or action movies with lots of sound effects.
CINEMA STUDIO EX. C ¹⁾²⁾ (Press CINEMA STUDIO EX. C button)	Reproduces the sound characteristics of the Sony Pictures Entertainment scoring stage using the 3D sound imaging of V. MULTI DIMENSION (page 34) to create 5 sets of virtual speakers surrounding the listener from a single pair of actual rear speakers.	This mode is ideal for watching musicals or classic films where music is featured in the soundtrack.
SEMI CINEMA STUDIO EX. A ¹⁾	Reproduces the sound characteristics of the Sony Pictures Entertainment “Cary Grant Theater” cinema production studio using the 3D sound imaging of V. SEMI-M. DIMENSION (page 34) to create 5 sets of virtual speakers surrounding the listener from the sound of the front speakers (without using actual rear speakers).	
SEMI CINEMA STUDIO EX. B ¹⁾	Reproduces the sound characteristics of the Sony Pictures Entertainment “Kim Novak Theater” cinema production studio using the 3D sound imaging of V. SEMI-M. DIMENSION (page 34) to create 5 sets of virtual speakers surrounding the listener from the sound of the front speakers (without using actual rear speakers).	
SEMI CINEMA STUDIO EX. C ¹⁾	Reproduces the sound characteristics of the Sony Pictures Entertainment scoring stage using the 3D sound imaging of V. SEMI-M. DIMENSION (page 34) to create 5 sets of virtual speakers surrounding the listener from the sound of the front speakers (without using actual rear speakers).	
NIGHT THEATER	Allows you to retain a theater like environment while listening at low volume levels, such as late at night.	
MONO MOVIE	Creates a theater like environment from movies with monaural soundtracks.	
STEREO MOVIE	Creates a theater like environment from movies recorded with stereo soundtracks	
HEADPHONE THEATER	Allows you to experience a theater like environment while listening through a pair of headphones.	Very effective with 5.1ch discreet signal sources like Dolby Digital and DTS.

¹⁾ “VIRTUAL” sound field: Sound field with virtual speakers.

However, turning the SUR menu “VIR. SPEAKERS” parameter off when using “CINEMA STUDIO EX. A~C” or “SEMI CINEMA STUDIO EX. A~C” reproduces the sound characteristics of each cinema production studio without virtual speakers.

²⁾ You can select directly by pressing the buttons on the front panel.

Selecting a Sound Field

Sound field	Effect	Notes
V. MULTI DIMENSION ¹⁾ (Virtual Multi Dimension)	Uses 3D sound imaging to create an array of virtual rear speakers positioned higher than the listener from a single pair of actual rear speakers. This mode creates 5 sets of virtual speakers surrounding the listener at approximately a 30° angle of elevation.	SIDE*
		MIDDLE*
		BEHIND*
* See page 20		
V. MULTI REAR ¹⁾ (Virtual Multi Rear)	Uses 3D sound imaging to create 3 sets of virtual rear speakers from 1 set of actual rear speakers.	SIDE*
		MIDDLE*
		BEHIND*
* See page 20		
V. SEMI-M. DIMENSION ¹⁾ (Virtual Semi Multi Dimension)	Uses 3D sound imaging to create virtual rear speakers from the sound of the front speakers without using actual rear speakers. This mode creates 5 sets of virtual speakers surrounding the listener at a 30° angle of elevation.	

¹⁾ “VIRTUAL” sound field: Sound field with virtual speakers.

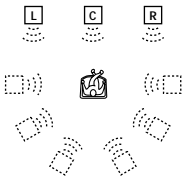
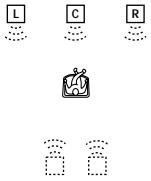
Sound field	Effect	Notes
VIRTUAL ENHANCED A ¹⁾ (Virtual Enhanced Surround A)	Uses 3D sound imaging to create 3 sets of virtual rear speakers from the sound of the front speakers without using actual rear speakers.	
VIRTUAL ENHANCED B ¹⁾ (Virtual Enhanced Surround B)	Uses 3D sound imaging to create 1 set of virtual rear speakers from the sound of the front speakers without using actual rear speakers.	
SMALL HALL	Reproduces the acoustics of a small rectangular concert hall.	Ideal for soft acoustic sounds.
LARGE HALL	Reproduces the acoustics of a large rectangular concert hall.	
OPERA HOUSE	Reproduces the acoustics of an opera house.	Ideal for musicals and opera.
JAZZ CLUB	Reproduces the acoustics of a jazz club.	
DISCO/CLUB	Reproduces the acoustics of a discotheque/dance club.	
CHURCH	Reproduces the acoustics of a stone church.	
LIVE HOUSE	Reproduces the acoustics of a 300-seat live house.	Great for rock or pop music.
ARENA	Reproduces the acoustics of a 1000-seat concert hall.	
STADIUM	Reproduces the feeling of a large open-air stadium.	Great for sporting events or electric (amplified) music.
GAME	Obtains maximum audio impact from video game software.	Be sure to set the game machine to stereo mode when using game software with stereo sound capabilities.

¹⁾ "VIRTUAL" sound field: Sound field with virtual speakers.

Notes

- The effects provided by the virtual speakers may cause increased noise in the playback signal.
- When listening to sound fields that employ the virtual speakers, you will not be able to hear any sound coming directly from the rear speakers.

Use the buttons on the front panel to operate the following modes

AUTO FORMAT DECODING (Press the A.F.D. button)	Automatically detects the type of audio signal being input (Dolby Digital, DTS, Dolby Pro Logic, or standard 2 channel stereo) and performs the proper decoding if necessary. This mode presents the sound as it was recorded/encoded, without adding any effects.	You can use this mode as a reference. Set the equalizer to OFF while using this mode to hear the source sound exactly as it was recorded.
2 CHANNEL (Press the 2CH button)	Outputs the sound from the front left and right speakers only. Standard two channel (stereo) sources completely bypass the sound field processing. Multi channel surround formats are downmixed to two channels.	This allows you to play any source using only the front left and right speakers.
ANALOG DIRECT (Press the ANLG DIRECT button)	The analog input signal is not digitally processed. Only volume control and the balance between the front left and front right speakers can be adjusted.	This mode is suitable for the enjoyment of high quality analog audio sources.

Note

No sound is output from the sub woofer when the 2 CHANNEL mode is selected. To listen to two channel (stereo) sources using the front left and right speakers and a sub woofer, use the AUTO FORMAT DECODING mode.

Understanding the Multi-Channel Surround Displays

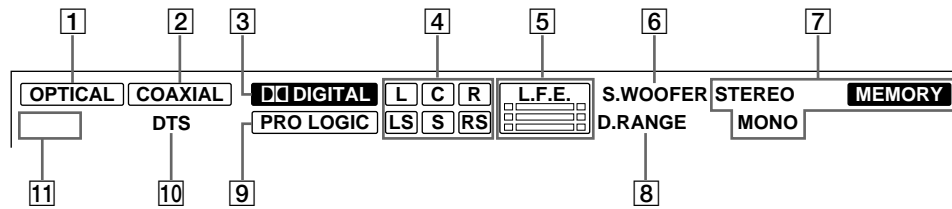

- 1** OPTICAL
Lights up when the source signal is a digital signal being input through the OPTICAL terminal.
- 2** COAXIAL
Lights up when the source signal is a digital signal being input through the COAXIAL terminal.
- 3** DIGITAL
This indicator lights when a sound field other than 2 CHANNEL is selected and the unit is decoding signals recorded in the Dolby Digital (AC-3) format.*
* However, this indicator does not light when the recording format is 2/0 or 2/0 Pro logic.
- 4** Playback channel indicators
The letters light to indicate the channels being played back.
L: Front Left R: Front Right
C: Center (monaural) LS: Left Surround
RS: Right Surround
S: Surround (monaural or the rear components obtained by Pro Logic processing)
The boxes around the letters light to indicate the speakers used to playback the channels.
See the next page for details regarding the playback channel indicators.
- 5** L.F.E.
The letters "L.F.E." light up when the disc being played contains the LFE (Low Frequency Effect) channel. When the sound of the LFE channel signal is actually being reproduced, the bars underneath the letters lights up to indicate the level. Since the LFE signal is not recorded in all parts of the input signal the bar indication will fluctuate (and may turn off) during playback.
- 6** S.WOOFER
Lights when sub woofer selection is set to "YES" and this unit detects that the disc being played does not contain the LFE channel signal. While this indicator is lit, this unit creates a sub woofer signal based on the low frequency components of the front channels.
- 7** Tuner indicators
These indicators light when using the receiver to tune in radio stations, etc. See pages 43-49 for tuner operations.
- 8** D. RANGE
Lights when dynamic range compression is active. See page 40 to adjust the dynamic range compression.
- 9** PRO LOGIC
Lights when this unit applies Pro Logic processing to two channel signals in order to output the center and surround channel signals.*
* However, this indicator does not light if the center and rear speakers are set to "NO" and the A.F.D. or NORMAL SURROUND sound fields are selected.
- 10** DTS
Lights up when DTS signals are input.

Note
When playing a DTS format disc, be sure that you have made digital connections and that INPUT MODE is NOT set to ANALOG (see **5** on page 27).
- 11**
Lights when Dolby Digital (AC-3) signals are input.

Source sound displays

The letters (L, C, R, etc.) indicate the source sound. The boxes around the letters vary to show how the receiver downmixes the source sound (based on the speakers settings). When using music sound modes like LARGE HALL or SMALL HALL the receiver adds reverberation based on the source sound.

The following table shows how the indicators light when using AUTO FORMAT DECODING mode.

Although the table below shows almost all of the configurations available from multi channel surround signals, the ones marked “ ☆ ” are the most common.

Recording Format (Front/Rear)	Input Channel Display	Source Sound and Output Channel Display			
		All speakers present	Rear speakers absent	Center speaker absent	Rear/center speakers absent
1/0	DOLBY DIGITAL [1/0]	<input checked="" type="checkbox"/> DOLBY DIGITAL <input checked="" type="checkbox"/> C	<input checked="" type="checkbox"/> DOLBY DIGITAL <input checked="" type="checkbox"/> C	<input checked="" type="checkbox"/> DOLBY DIGITAL <input type="checkbox"/> c <input type="checkbox"/>	<input checked="" type="checkbox"/> DOLBY DIGITAL <input type="checkbox"/> c <input type="checkbox"/>
	— dts [1/0]	<input type="checkbox"/> DTS <input checked="" type="checkbox"/> C	<input type="checkbox"/> DTS <input checked="" type="checkbox"/> C	<input type="checkbox"/> DTS <input type="checkbox"/> c <input type="checkbox"/>	<input type="checkbox"/> DTS <input type="checkbox"/> c <input type="checkbox"/>
2/0*	DOLBY DIGITAL [2/0]	<input type="checkbox"/> L <input type="checkbox"/> R	<input type="checkbox"/> L <input type="checkbox"/> R	<input type="checkbox"/> L <input type="checkbox"/> R	<input type="checkbox"/> L <input type="checkbox"/> R
	— dts [2/0]	<input type="checkbox"/> DTS <input type="checkbox"/> L <input type="checkbox"/> R	<input type="checkbox"/> DTS <input type="checkbox"/> L <input type="checkbox"/> R	<input type="checkbox"/> DTS <input type="checkbox"/> L <input type="checkbox"/> R	<input type="checkbox"/> DTS <input type="checkbox"/> L <input type="checkbox"/> R
3/0	DOLBY DIGITAL [3/0]	<input checked="" type="checkbox"/> DOLBY DIGITAL <input checked="" type="checkbox"/> L <input checked="" type="checkbox"/> C <input checked="" type="checkbox"/> R	<input checked="" type="checkbox"/> DOLBY DIGITAL <input checked="" type="checkbox"/> L <input checked="" type="checkbox"/> C <input checked="" type="checkbox"/> R	<input checked="" type="checkbox"/> DOLBY DIGITAL <input type="checkbox"/> L <input checked="" type="checkbox"/> c <input checked="" type="checkbox"/> R	<input checked="" type="checkbox"/> DOLBY DIGITAL <input type="checkbox"/> L <input checked="" type="checkbox"/> c <input checked="" type="checkbox"/> R
	— dts [3/0]	<input type="checkbox"/> DTS <input type="checkbox"/> L <input checked="" type="checkbox"/> C <input checked="" type="checkbox"/> R	<input type="checkbox"/> DTS <input type="checkbox"/> L <input checked="" type="checkbox"/> C <input checked="" type="checkbox"/> R	<input type="checkbox"/> DTS <input type="checkbox"/> L <input checked="" type="checkbox"/> c <input checked="" type="checkbox"/> R	<input type="checkbox"/> DTS <input type="checkbox"/> L <input checked="" type="checkbox"/> c <input checked="" type="checkbox"/> R
2/1	DOLBY DIGITAL [2/1]	<input checked="" type="checkbox"/> DOLBY DIGITAL <input type="checkbox"/> L <input type="checkbox"/> R <input checked="" type="checkbox"/> S	<input checked="" type="checkbox"/> DOLBY DIGITAL <input type="checkbox"/> L <input type="checkbox"/> R <input checked="" type="checkbox"/> S	<input checked="" type="checkbox"/> DOLBY DIGITAL <input type="checkbox"/> L <input type="checkbox"/> R <input checked="" type="checkbox"/> S	<input checked="" type="checkbox"/> DOLBY DIGITAL <input type="checkbox"/> L <input type="checkbox"/> R <input checked="" type="checkbox"/> S
	— dts [2/1]	<input type="checkbox"/> DTS <input type="checkbox"/> L <input type="checkbox"/> R <input checked="" type="checkbox"/> S	<input type="checkbox"/> DTS <input type="checkbox"/> L <input type="checkbox"/> R <input checked="" type="checkbox"/> S	<input type="checkbox"/> DTS <input type="checkbox"/> L <input type="checkbox"/> R <input checked="" type="checkbox"/> S	<input type="checkbox"/> DTS <input type="checkbox"/> L <input type="checkbox"/> R <input checked="" type="checkbox"/> S
3/1	DOLBY DIGITAL [3/1]	<input checked="" type="checkbox"/> DOLBY DIGITAL <input checked="" type="checkbox"/> L <input checked="" type="checkbox"/> C <input checked="" type="checkbox"/> R <input checked="" type="checkbox"/> S	<input checked="" type="checkbox"/> DOLBY DIGITAL <input checked="" type="checkbox"/> L <input checked="" type="checkbox"/> C <input checked="" type="checkbox"/> R <input checked="" type="checkbox"/> S	<input checked="" type="checkbox"/> DOLBY DIGITAL <input type="checkbox"/> L <input checked="" type="checkbox"/> c <input checked="" type="checkbox"/> R <input checked="" type="checkbox"/> S	<input checked="" type="checkbox"/> DOLBY DIGITAL <input type="checkbox"/> L <input checked="" type="checkbox"/> c <input checked="" type="checkbox"/> R <input checked="" type="checkbox"/> S
	— dts [3/1]	<input type="checkbox"/> DTS <input type="checkbox"/> L <input checked="" type="checkbox"/> C <input checked="" type="checkbox"/> R <input checked="" type="checkbox"/> S	<input type="checkbox"/> DTS <input type="checkbox"/> L <input checked="" type="checkbox"/> C <input checked="" type="checkbox"/> R <input checked="" type="checkbox"/> S	<input type="checkbox"/> DTS <input type="checkbox"/> L <input checked="" type="checkbox"/> c <input checked="" type="checkbox"/> R <input checked="" type="checkbox"/> S	<input type="checkbox"/> DTS <input type="checkbox"/> L <input checked="" type="checkbox"/> c <input checked="" type="checkbox"/> R <input checked="" type="checkbox"/> S
2/2	DOLBY DIGITAL [2/2]	<input checked="" type="checkbox"/> DOLBY DIGITAL <input type="checkbox"/> L <input type="checkbox"/> R <input checked="" type="checkbox"/> LS <input checked="" type="checkbox"/> RS	<input checked="" type="checkbox"/> DOLBY DIGITAL <input type="checkbox"/> L <input type="checkbox"/> R <input checked="" type="checkbox"/> LS <input checked="" type="checkbox"/> RS	<input checked="" type="checkbox"/> DOLBY DIGITAL <input type="checkbox"/> L <input type="checkbox"/> R <input checked="" type="checkbox"/> LS <input checked="" type="checkbox"/> RS	<input checked="" type="checkbox"/> DOLBY DIGITAL <input type="checkbox"/> L <input type="checkbox"/> R <input checked="" type="checkbox"/> LS <input checked="" type="checkbox"/> RS
	— dts [2/2]	<input type="checkbox"/> DTS <input type="checkbox"/> L <input type="checkbox"/> R <input checked="" type="checkbox"/> LS <input checked="" type="checkbox"/> RS	<input type="checkbox"/> DTS <input type="checkbox"/> L <input type="checkbox"/> R <input checked="" type="checkbox"/> LS <input checked="" type="checkbox"/> RS	<input type="checkbox"/> DTS <input type="checkbox"/> L <input type="checkbox"/> R <input checked="" type="checkbox"/> LS <input checked="" type="checkbox"/> RS	<input type="checkbox"/> DTS <input type="checkbox"/> L <input type="checkbox"/> R <input checked="" type="checkbox"/> LS <input checked="" type="checkbox"/> RS
3/2	☆ DOLBY DIGITAL [3/2]	<input checked="" type="checkbox"/> DOLBY DIGITAL <input checked="" type="checkbox"/> L <input checked="" type="checkbox"/> C <input checked="" type="checkbox"/> R <input checked="" type="checkbox"/> LS <input checked="" type="checkbox"/> RS	<input checked="" type="checkbox"/> DOLBY DIGITAL <input checked="" type="checkbox"/> L <input checked="" type="checkbox"/> C <input checked="" type="checkbox"/> R <input checked="" type="checkbox"/> LS <input checked="" type="checkbox"/> RS	<input checked="" type="checkbox"/> DOLBY DIGITAL <input type="checkbox"/> L <input checked="" type="checkbox"/> c <input checked="" type="checkbox"/> R <input checked="" type="checkbox"/> LS <input checked="" type="checkbox"/> RS	<input checked="" type="checkbox"/> DOLBY DIGITAL <input type="checkbox"/> L <input checked="" type="checkbox"/> c <input checked="" type="checkbox"/> R <input checked="" type="checkbox"/> LS <input checked="" type="checkbox"/> RS
	☆ dts [3/2]	<input type="checkbox"/> DTS <input type="checkbox"/> L <input checked="" type="checkbox"/> C <input checked="" type="checkbox"/> R <input checked="" type="checkbox"/> LS <input checked="" type="checkbox"/> RS	<input type="checkbox"/> DTS <input type="checkbox"/> L <input checked="" type="checkbox"/> C <input checked="" type="checkbox"/> R <input checked="" type="checkbox"/> LS <input checked="" type="checkbox"/> RS	<input type="checkbox"/> DTS <input type="checkbox"/> L <input checked="" type="checkbox"/> c <input checked="" type="checkbox"/> R <input checked="" type="checkbox"/> LS <input checked="" type="checkbox"/> RS	<input type="checkbox"/> DTS <input type="checkbox"/> L <input checked="" type="checkbox"/> c <input checked="" type="checkbox"/> R <input checked="" type="checkbox"/> LS <input checked="" type="checkbox"/> RS
2/0**	☆ DOLBY DIGITAL [2/0]	<input type="checkbox"/> PRO LOGIC <input checked="" type="checkbox"/> L <input checked="" type="checkbox"/> C <input checked="" type="checkbox"/> R <input checked="" type="checkbox"/> S	<input type="checkbox"/> PRO LOGIC <input checked="" type="checkbox"/> L <input checked="" type="checkbox"/> C <input checked="" type="checkbox"/> R <input checked="" type="checkbox"/> S	<input type="checkbox"/> PRO LOGIC <input type="checkbox"/> L <input checked="" type="checkbox"/> c <input checked="" type="checkbox"/> R <input checked="" type="checkbox"/> S	<input type="checkbox"/> L <input type="checkbox"/> R
	☆ DOLBY PROLOGIC	<input type="checkbox"/> PRO LOGIC <input checked="" type="checkbox"/> L <input checked="" type="checkbox"/> C <input checked="" type="checkbox"/> R <input checked="" type="checkbox"/> S	<input type="checkbox"/> PRO LOGIC <input checked="" type="checkbox"/> L <input checked="" type="checkbox"/> C <input checked="" type="checkbox"/> R <input checked="" type="checkbox"/> S	<input type="checkbox"/> PRO LOGIC <input type="checkbox"/> L <input checked="" type="checkbox"/> c <input checked="" type="checkbox"/> R <input checked="" type="checkbox"/> S	<input type="checkbox"/> L <input type="checkbox"/> R
	☆ PCM XX kHz***	<input type="checkbox"/> L <input type="checkbox"/> R	<input type="checkbox"/> L <input type="checkbox"/> R	<input type="checkbox"/> L <input type="checkbox"/> R	<input type="checkbox"/> L <input type="checkbox"/> R

* Signals with Dolby surround encoded flag OFF

** Signals with Dolby surround encoded flag ON

*** Sampling frequency is displayed

Notes

- The receiver performs Pro Logic decoding and the display conforms to 2/0** when using the following movie sound modes with 2/0* or STEREO PCM format signals. (CINEMA STUDIO EX. A, B, C, SEMI CINEMA STUDIO EX. A, B, C, NIGHT THEATER, V. MULTI DIMENSION, V. MULTI REAR, V. SEMI-M. DIMENSION, VIRTUAL ENHANCED A, or VIRTUAL ENHANCED B)
- When using music sound modes like LARGE HALL or SMALL HALL with standard audio formats, like PCM, the receiver creates rear signals from the front L and R signals. In this case, sound is output from the rear speakers, but output channel indicators for the rear speakers do not light.

Customizing Sound Fields

By adjusting the surround parameters and the equalization of the front, rear and center speakers, you can customize the sound fields to suit your particular listening situation.

Once you customize a sound field, the changes are stored in the memory indefinitely (unless the receiver is unplugged for about two weeks). You can change a customized sound field any time by making new adjustments to the parameters.

See the table on page 41 for the parameters available in each sound field.

To get the most from multi channel surround sound

Position your speakers and do the procedures described in “Multi Channel Surround Setup” starting from page 19 before you customize a sound field.

Adjusting the surround parameters

The SUR menu contains parameters that let you customize various aspects of the current sound field. The settings available in this menu are stored individually for each sound field.

- 1 Start playing a program source encoded with multi channel surround sound.**
- 2 Press SUR.**
The button lights up and the first parameter is displayed.
- 3 Press the cursor buttons (< or >) to select the parameter you want to adjust.**
- 4 Turn the jog dial to select the setting you desire.**
The setting is entered automatically.

Effect level (EFFECT)

Initial setting : (depends on sound mode)

This parameter lets you adjust the “presence” of the current surround effect.

Wall type (WALL)

Initial setting : midpoint

When sound is reflected off soft material, such as a curtain, the high frequency elements are reduced. A hard wall is highly reflective and does not significantly effect the frequency response of the reflected sound. This parameter lets you control the level of the high frequencies to alter the sonic character of your listening environment by simulating a softer (S) or harder (H) wall. The midpoint designates a neutral wall (made of wood).

Reverberation (REVERB)

Initial setting : midpoint

Before sound reaches our ears, it is reflected (reverberated) many times between the left and right walls, ceiling, and floor. In a large room, sound takes more time to bounce from one surface to another than in a smaller room. This parameter lets you control the spacing of the early reflections to simulate a sonically longer (L) or shorter (S) room.

- The reverberation can be adjusted ± 8 from S (short, -8) to L (long, +8) in 17 steps.
- The midpoint (0) designates a standard room with no adjustment.

Screen depth (SCREEN DEPTH)

Initial setting : MID

In a movie theater, sound seems to come from inside the image reflected on the movie screen. This parameter allows you to create the same sensation in your listening room by shifting the sound of the front speakers “into” the screen.

- The screen depth can be set to OFF, MID, or DEEP.
- DEEP provides the greatest amount of screen depth.

Virtual speaker (VIR. SPEAKERS)

Initial setting : ON

Allows you turn the virtual speakers created by the CINEMA STUDIO EX. A, B, C and SEMI CINEMA STUDIO EX. A, B, C sound fields off or on.

Adjusting the level parameters

The LEVEL menu contains parameters that let you adjust the balance and speaker volumes of each speaker. The settings available in this menu are applied to all sound fields.

- 1 Start playing a program source encoded with multi channel surround sound.
- 2 Press LEVEL.
The button lights up and the first parameter is displayed.
- 3 Press the cursor buttons (< or >) to select the parameter you want to adjust.
- 4 Turn the jog dial to select the setting you desire.
The setting is entered automatically.

Front balance (FRONT)

Initial setting : center

Lets you adjust the balance between the front left and right speakers. The level can even be adjusted during 5.1 CH input.

- The balance can be adjusted ± 8 dB in 1 dB steps.
- This settings can also be adjusted using the supplied remote. See "Adjusting the speaker volume" (page 22).

Rear balance (REAR)

Initial setting : center

Lets you adjust the balance between the rear left and right speakers. The level can even be adjusted during 5.1 CH input.

- The balance can be adjusted ± 8 dB in 1 dB steps.
However, during 5.1CH input, the balance can be adjusted ± 4 dB in 1 dB steps.
- This settings can also be adjusted using the supplied remote. See "Adjusting the speaker volume" (page 22).

Rear level (REAR)

Initial setting : 0 dB

Lets you adjust level of the rear (left and right) speakers. The level can even be adjusted during 5.1 CH input.

- The level can be adjusted in 1 dB steps from -10 dB to $+10$ dB. However, during 5.1CH input, the level can be adjusted in 1 dB steps from -6 dB to $+10$ dB steps.
- This settings can also be adjusted directly using the supplied remote. See "Adjusting the speaker volume" (page 22).

Center level (CENTER)

Initial setting : 0 dB

Lets you adjust the level of the center speaker. The level can even be adjusted during 5.1 CH input.

- The level can be adjusted in 1 dB steps from -10 dB to $+10$ dB.

Sub woofer level (SUB WOOFER)

Initial setting : 0 dB

Lets you adjust the level of the sub woofer. The level can even be adjusted during 5.1 CH input.

- The level can be adjusted in 1 dB steps from -10 dB to $+10$ dB.

LFE (Low Frequency Effect) mix level

Initial setting : 0 dB

This parameter lets you attenuate the level of the LFE (Low Frequency Effect) channel output from the sub woofer without effecting the level of the bass frequencies sent to the sub woofer from the front, center or rear channels via the Dolby Digital (AC-3) bass redirection circuitry.

- The level can be adjusted in 1 dB steps from -20 dB to 0 dB (line level). 0 dB outputs the full LFE signal at the mix level determined by the recording engineer.
- Selecting OFF mutes the sound of the LFE channel from the sub woofer. However, the low frequency sounds of the front, center, or rear speakers are output from the sub woofer according to the settings made for each speaker in the speaker setup (page 18~21).

dts LFE (Low Frequency Effect) mix level

Initial setting : 0 dB

This parameter lets you attenuate the level of the LFE (Low Frequency Effect) channel output from the sub woofer without effecting the level of the bass frequencies sent to the sub woofer from the front, center or rear channels via the "dts" bass redirection circuitry.

- The level can be adjusted in 1 dB steps from $+10.0$ dB to -20.0 dB (line level).
- Selecting OFF mutes the sound of the LFE channel from the sub woofer. However, the low frequency sounds of the front, center, or rear speakers are output from the sub woofer according to the settings made for each speaker in the speaker setup (page 18~21).

💡 About the level differences in the LFE MIX settings
The “dts LFE MIX” level is set to +10.0 dB and “LFE MIX” (Dolby Digital) is set to 0 dB.

Dynamic range compressor (D. RANGE COMP)

Initial setting : OFF

Lets you compress the dynamic range of the sound track. This may be useful when you want to watch movies at low volumes late at night.

- OFF reproduces the sound track with no compression.
- STD reproduces the sound track with the dynamic range intended by the recording engineer.
- 0.1 ~ 0.9 allow you to compress the dynamic range in small steps to achieve the sound you desire.
- MAX provides a dramatic compression of the dynamic range.

Note

Dynamic range compression is possible with Dolby Digital sources only.

💡 About the Dynamic Range Compressor

This parameter allows you to compress the dynamic range of the soundtrack based on the dynamic range information included in the Dolby Digital signal. “STD” is standard compression, but because many sources have only light compression, you may not notice much difference when using 0.1~0.9.

Therefore, we recommend using the “MAX” setting. This greatly compresses the dynamic range and allows you to view movies late at night at low volumes. Unlike analog limiters, the levels are predetermined and provide a very natural compression.

Adjusting the equalizer

The EQ menu lets you adjust the equalization (low, mid, and high frequencies) of the front, rear and center speakers. The equalizer settings are stored individually for each sound field.

- 1 Start playing a program source encoded with multi channel surround sound.
- 2 Press EQ.
The button lights up and the first parameter is displayed.
- 3 Press the cursor buttons (< or >) to select the parameter you want to adjust.
- 4 Turn the jog dial to select the setting you desire.
The setting is entered automatically.

💡 You can turn off the equalization without erasing it
The equalizer settings are stored separately for each sound field. Press the EQUALIZER button to turn the EQ indicator off.

Front speaker bass adjustment (Level/Frequency)

- ① Use the cursor buttons (</>) to select the level (dB) or frequency (Hz).
 - ② Use the jog dial to adjust.
- Repeat until you achieve the sound you desire.
- The level can be adjusted ± 10 dB in 1 dB steps.
 - The frequency can be adjusted from 100 Hz to 1.0 kHz in 21 steps.

Front speaker midrange adjustment (Level/Frequency)

Adjust as described in “Front speaker bass adjustment”.

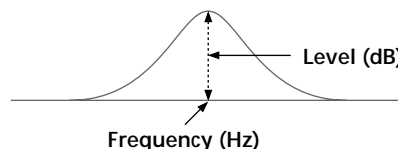

- The level can be adjusted ± 10 dB in 1 dB steps.
- The frequency can be adjusted from 500 Hz to 5 kHz in 21 steps.

Front speaker treble adjustment (Level/Frequency)

Adjust as described in “Front speaker bass adjustment”.

- The level can be adjusted ± 10 dB in 1 dB steps.
- The frequency can be adjusted from 1.0 kHz to 10 kHz in 21 steps.

Center speaker bass adjustment (Level/Frequency)

Adjust as described in “Front speaker bass adjustment”.

- The level can be adjusted ± 10 dB in 1 dB steps.
- The frequency can be adjusted from 100 Hz to 1.0 kHz in 21 steps.

Center speaker midrange adjustment (Level/Frequency)

Adjust as described in “Front speaker bass adjustment”.

- The level can be adjusted ± 10 dB in 1 dB steps.
- The frequency can be adjusted from 500 Hz to 5.0 kHz in 21 steps.

Center speaker treble adjustment (Level/Frequency)

Adjust as described in “Front speaker bass adjustment”.

- The level can be adjusted ± 10 dB in 1 dB steps.
- The frequency can be adjusted from 1.0 kHz to 10 kHz in 21 steps.

Rear speaker bass adjustment (Level/Frequency)

Adjust as described in “Front speaker bass adjustment”.

- The level can be adjusted ± 10 dB in 1 dB steps.
- The frequency can be adjusted from 100 Hz to 1.0 kHz in 21 steps.

Rear speaker midrange adjustment (Level/Frequency)

Adjust as described in “Front speaker bass adjustment”.

- The level can be adjusted ± 10 dB in 1 dB steps.
- The frequency can be adjusted from 500 Hz to 5.0 kHz in 21 steps.

Rear speaker treble adjustment (Level/Frequency)

Adjust as described in “Front speaker bass adjustment”.

- The level can be adjusted ± 10 dB in 1 dB steps.
- The frequency can be adjusted from 1.0 kHz to 10 kHz in 21 steps.

Resetting customized sound fields to the factory settings

- 1 If the power is on, press I/⏻ to turn off the power.
- 2 Hold down MODE + and press I/⏻.
“S.F Initialize” appears in the display and all sound fields are reset at once.

Adjustable parameters for each sound field

	<	SUR	>
	EFFECT LEVEL	WALL TYPE	REVERB TIME
	SCREEN DEPTH	VIRTUAL SPEAKER	
2CH			
A.F.D.			
NORMAL SURROUND			
CINEMA STUDIO EX. A	●		● ●
CINEMA STUDIO EX. B	●		● ●
CINEMA STUDIO EX. C	●		● ●
SEMI CINEMA STUDIO EX. A	●		● ●
SEMI CINEMA STUDIO EX. B	●		● ●
SEMI CINEMA STUDIO EX. C	●		● ●
NIGHT THEATER	●	●	●
MONO MOVIE	●	●	●
STEREO MOVIE	●	●	●
HEADPHONE THEATER	●		
V. MULTI DIMENSION			
V. MULTI REAR			
V. SEMI-M. DIMENSION			
VIRTUAL ENHANCED A			
VIRTUAL ENHANCED B			
SMALL HALL	●	●	●
LARGE HALL	●	●	●
OPERA HOUSE	●	●	●
JAZZ CLUB	●	●	●
DISCO/CLUB	●	●	●
CHURCH	●	●	●
LIVE HOUSE	●	●	●
ARENA	●	●	●
STADIUM	●	●	●
GAME	●	●	●
5.1CH INPUT			
ANALOG DIRECT			

●:can be stored in each sound field.

■:The stored parameter is applied to all of the sound fields.

Customizing Sound Fields

Adjustable parameters for each sound field (continued)

	<	LEVEL						>>	EQ			>
	FRONT BAL.	REAR BAL.	REAR LEVEL	CENTER LEVEL	WOOFER LEVEL	(dts) LFE MIX*	D.RANGE COMP.*	FRONT EQ	CENTER EQ	REAR EQ		
2CH	■					■	■	●				
A.F.D.	■	■	■	■	■	■	■	●	●	●		
NORMAL SURROUND	■	■	■	■	■	■	■	●	●	●		
CINEMA STUDIO EX. A	■	■	■	■	■	■	■	●	●	●		
CINEMA STUDIO EX. B	■	■	■	■	■	■	■	●	●	●		
CINEMA STUDIO EX. C	■	■	■	■	■	■	■	●	●	●		
SEMI CINEMA STUDIO EX. A	■			■	■	■	■	●	●			
SEMI CINEMA STUDIO EX. B	■			■	■	■	■	●	●			
SEMI CINEMA STUDIO EX. C	■			■	■	■	■	●	●			
NIGHT THEATER	■	■	■	■	■	■	■	●	●	●		
MONO MOVIE	■	■	■	■	■	■	■	●	●	●		
STEREO MOVIE	■	■	■	■	■	■	■	●	●	●		
HEADPHONE THEATER	■						■					
V. MULTI DIMENSION	■	■	■	■	■	■	■	●	●	●		
V. MULTI REAR	■	■	■	■	■	■	■	●	●	●		
V. SEMI-M. DIMENSION	■			■	■	■	■	●	●			
VIRTUAL ENHANCED A	■			■	■	■	■	●	●			
VIRTUAL ENHANCED B	■			■	■	■	■	●	●			
SMALL HALL	■	■	■	■	■	■	■	●	●	●		
LARGE HALL	■	■	■	■	■	■	■	●	●	●		
OPERA HOUSE	■	■	■	■	■	■	■	●	●	●		
JAZZ CLUB	■	■	■	■	■	■	■	●	●	●		
DISCO/CLUB	■	■	■	■	■	■	■	●	●	●		
CHURCH	■	■	■	■	■	■	■	●	●	●		
LIVE HOUSE	■	■	■	■	■	■	■	●	●	●		
ARENA	■	■	■	■	■	■	■	●	●	●		
STADIUM	■	■	■	■	■	■	■	●	●	●		
GAME	■	■	■	■	■	■	■	●	●	●		
5.1CH INPUT	■	■	■	■	■							
ANALOG DIRECT	■					■	■					

●:can be stored in each sound field.

■:The stored parameter is applied to all of the sound fields.

* These parameters may not operate depending on the source or may not operate as adjusted. For details, see each item in “Adjusting the level parameters” (page 39).

Receiving Broadcasts

This chapter describes how to receive FM or AM broadcasts and how to preset selected stations.

You can tune in stations on this receiver in the following ways:

Automatic FM Memory (AUTOBETICAL)

– Models of area code CED only

You can have the receiver automatically store up to 30 of the clearest FM and FM RDS stations in alphabetical order (see page 44).

Direct Tuning

You can enter a frequency of the station you want directly by using the numeric buttons on the supplied remote (see page 45).

Automatic Tuning

If you don't know the frequency of the station you want, you can let the receiver scan all available stations in your area (see page 45).

Preset Tuning

After you have tuned in stations using Direct Tuning or Automatic Tuning, you can preset them to the receiver (see page 46). Then you can tune in any of the stations directly by entering its 2-character code using the supplied remote (see page 46). Up to 30 FM or AM stations can be preset. The receiver will also scan all the stations that you have preset (see page 46).

RDS functions

– Models of area code CED only

This receiver also allows you to use RDS (Radio Data System), which enables radio stations to send additional information along with the regular program signal. You can use the following three convenient RDS features:

- Displaying RDS information (see page 47)
- Scanning preset stations by program type (see page 47)
- Using the EON function (see page 48)

Note that RDS is operable only for FM stations.*

** Not all FM stations provide RDS service, nor do they provide the same types of services. If you are not familiar with the RDS services in your area, check with your local radio stations for details.*

Before you begin, make sure you have:

- Connected FM and AM antennas to the receiver (see page 5).

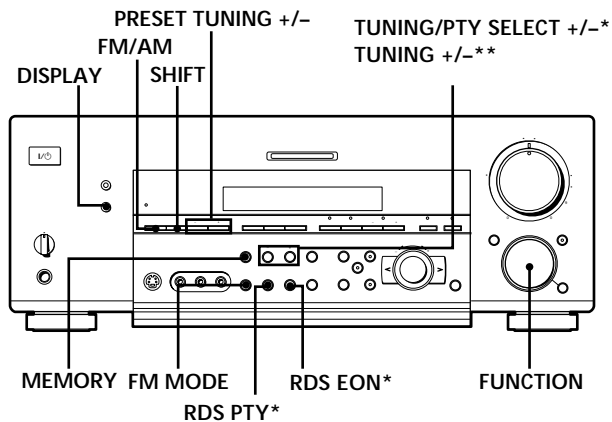

Brief descriptions of buttons used to receive broadcasts

PRESET TUNING +/- buttons: Press to scan all preset radio stations.

DISPLAY button: Press to display the RDS information.

MEMORY button: Uses for memorizing preset stations.

TUNING/PTY SELECT +/- buttons*: Press to scan all available radio stations or select program types.

TUNING +/- buttons:** Press to scan all available radio stations.

FUNCTION control: Rotate to select the tuner.

RDS EON button*: Press to set the receiver to switch stations automatically.

RDS PTY button*: Press to scan preset stations by the program type.

FM MODE button: If “STEREO” flashes in the display and the FM stereo reception is poor, press this button to improve the sound. You will not be able to enjoy stereo effect but the sound will be less distorted.

Note

If “STEREO” does not appear at all even when the FM broadcast is received normally, press this button to turn on the “STEREO” indication.

FM/AM button: Press to select the FM or AM band.

SHIFT button: Press to select a memory page (A, B, or C) for presetting radio stations or tuning to preset stations.

* Models of area code CED only.

** Except for models of area code CED.

Storing FM Stations Automatically (AUTOBETICAL)

This function lets you store up to 30 FM and FM RDS stations in alphabetical order without redundancy. Additionally, it only stores the stations with the clearest signals (This function is for models of area code CED only).

If you want to store FM or AM stations one by one, see “Presetting radio stations” on page 46.

For details on the buttons used in this section, see “Brief descriptions of buttons used to receive broadcasts” on this page.

- 1 Press I/⏻ to turn off the receiver.
- 2 Hold down MEMORY and press I/⏻ to turn the receiver back on.
“Autobetrical select” appears in the display and the receiver scans and stores all the FM and FM RDS stations in the broadcast area.
For RDS stations, the tuner first checks for stations broadcasting the same program, then stores only the one with the clearest signal. The selected RDS stations are sorted alphabetically by their Program Service name, then assigned a two character preset code. For more details on RDS see page 47.
Regular FM stations are assigned two character preset codes and stored after the RDS station.
When done, “Autobetrical finish” appears in the display momentarily and the receiver returns to normal operation.

Notes

- Do not press any of the buttons on the receiver or supplied remote during autobetrical operation.
- If you move to another area, repeat this procedure to store stations in your new area.
- For details on tuning the stored stations, see page 46.
- The FM MODE setting is also stored along with the station.
- If you move the antenna after storing stations with this procedure, the stored settings may no longer be valid. If this happens, repeat this procedure to store the stations again.

Direct Tuning

Use the supplied remote to perform the following operations. For details on the buttons used in this section, see the operating instructions for the supplied remote.

- 1 Rotate **FUNCTION** to select the tuner.
The last received station is tuned in.
- 2 Press **FM/AM** to select the FM or AM band.
- 3 Press **D. TUNING**.
- 4 Press the numeric buttons to enter the frequency.

Example 1: FM 102.50 MHz

① → ② → ⑤ → ⑦ → ①

Example 2: AM 1350 kHz

(You don't have to enter the last "0" when the tuning scale is set to 10 kHz.)

① → ③ → ⑤ → ①

If you cannot tune in a station and the entered numbers flash

Make sure you've entered the right frequency. If not, repeat Steps 3 and 4.

If the entered numbers still flash, the frequency is not used in your area.

- 5 If you've tuned in an AM station, adjust the direction of the AM loop antenna for optimum reception.
- 6 Repeat Steps 2 to 5 to receive another station.

 If you try to enter a frequency that is too precise for the tuning scale

The entered value is automatically rounded up or down.

The tuning scale for direct tuning differs depending on the area code as shown in the following table. For details on area codes, see page 3.

Area code	FM tuning scale	AM tuning scale
U, CA	50 kHz	10 kHz (can be changed to 9 kHz)*
AU, CN, SP, CED	50 kHz	9 kHz

* To change the AM tuning scale, see page 60.

Automatic Tuning

For details on the buttons used in this section, see "Brief descriptions of buttons used to receive broadcasts" on page 44.

- 1 Rotate **FUNCTION** to select the tuner.
The last received station is tuned in.
- 2 Press **FM/AM** to select the FM or AM band.
- 3 Press **TUNING (PTY SELECT) +** or **TUNING (PTY SELECT) -**.
Press the + button to scan from low to high; press the - button to scan from high to low.
The receiver stops scanning whenever a station is received.

When the receiver reaches either end of the band
Scanning is repeated in the same direction.
- 4 To continue scanning, press **TUNING (PTY SELECT) +** or **TUNING (PTY SELECT) -** again.

Preset Tuning

For details on the buttons used in this section, see “Brief descriptions of buttons used to receive broadcasts” on page 44.

Before tuning to preset stations, be sure to preset them by performing steps on “Presetting radio stations” below.

Presetting radio stations

- 1 Rotate **FUNCTION** to select the tuner.
The last received station is tuned in.
- 2 Tune in the station that you want to preset using **Direct Tuning** (page 45) or **Automatic Tuning** (page 45).
- 3 Press **MEMORY**.
“MEMORY” appears in the display for a few seconds.
Do Steps 4 to 6 before “MEMORY” goes out.
- 4 Press **SHIFT** to select a memory page (A, B or C).
Each time you press **SHIFT**, the letter “A,” “B” or “C” appears in the display.
- 5 Press **PRESET TUNING +** or **PRESET TUNING -** to select a preset number.
If “MEMORY” goes out before you press the preset number, start again from Step 3.
- 6 Press **MEMORY** again to store the station.
If “MEMORY” goes out before you press the preset number, start again from Step 3.
- 7 Repeat Steps 2 to 6 to preset another station.

To change a preset number to another station

Do Steps 1 to 6 to preset the new station to the number.

Note

If the AC power cord is disconnected for about two weeks, all the preset stations will be cleared from the receiver’s memory, and you will have to preset the stations again.

Tuning to preset stations

You can tune the preset stations either of the following two ways.

Scanning the preset stations

- 1 Rotate **FUNCTION** to select the tuner.
The last received station is tuned in.
- 2 Press **PRESET TUNING +** or **PRESET TUNING -** repeatedly to select the preset station you want.
Each time you press the button, the receiver tunes in one preset station at a time, in the corresponding order and direction as follows:

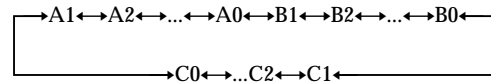

Using the preset codes

Use the supplied remote to perform the following operations. For details on the buttons used in this section, see the operating instructions for the supplied remote.

- 1 Rotate **FUNCTION** to select the tuner.
The last received station is tuned in.
- 2 For remotes without a display:
Press **SHIFT** to select a memory page (A, B, or C), then press the preset number of the station you want using the numeric buttons on the supplied remote.

For remotes with a display:

Select the preset station you want from the list displayed on the supplied remote when **TUNER** is selected.

Using the Radio Data System (RDS)

(This function is for models of area code CED only.)

Receiving RDS broadcasts

Simply select a station on the FM band using direct tuning (page 45), automatic tuning (page 45), or preset tuning (page 46).

When you tune in a station that provides RDS services, the RDS indicator lights up and the program station name appears in the display.

Note

RDS may not work properly if the station you tuned to is not transmitting the RDS signal properly or if the signal strength is weak.

Displaying RDS information

While receiving an RDS station, press DISPLAY repeatedly to change the RDS information on the display window as follows:

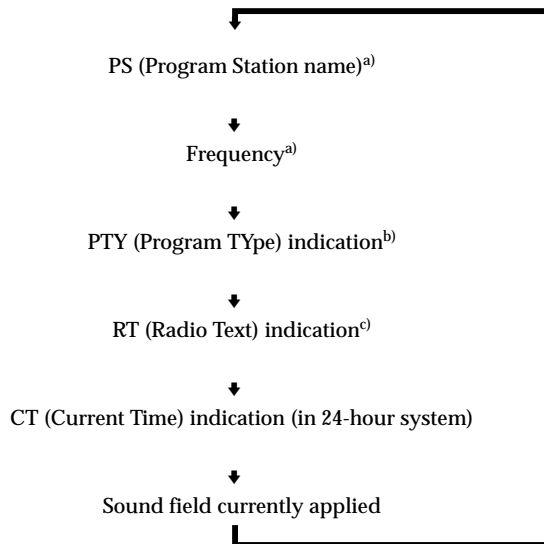

a) This information also appears for non-RDS FM stations.

b) Type of program being broadcast. (See page 48.)

c) Text messages sent by the RDS station

Notes

- If there is an emergency announcement by government authorities, “Alarm-Alarm!” flashes in the display.
- If a station does not provide a particular RDS service, “No XX” (such as “No Clock Time”) appears in the display.
- When a station broadcasts radio text data, it is displayed at the same rate at which it is sent from the station. Any change in this rate is reflected in the display rate of the data.

Scanning preset stations by program type

You can tune in preset stations according to a program type that you specify. The receiver scans for stations in its preset memory currently broadcasting the specified program type.

1 Press RDS PTY.

2 Press (TUNING) PTY SELECT + or (TUNING) PTY SELECT – to select the program type.

See the table on the next page for information on each program type.

3 Press RDS PTY.

While the receiver is scanning stations, “PTY SEARCH” and the program type indication appear alternately in the display window.

When the receiver finds a station, the receiver stops scanning.

When the receiver could not find any preset stations currently broadcasting the specified program type, “PTY not found” appears in the display.

Using the EON function

The EON (Enhanced Other Network) function allows the receiver to switch automatically to a station broadcasting traffic announcements, news, or information programs. When such a program starts on a station networking with the preset FM RDS station, the receiver automatically tunes in the station.

After the program ends, the receiver switches back to the original preset station or the program source you were originally listening to.

Using the Radio Data System (RDS)

- 1 Tune in a preset FM RDS station so that the RDS indicator lights up.
- 2 Press RDS EON repeatedly to select the type of the program to be tuned in. Each time you press the RDS EON button, the indication for the type of the program lights up alternately as shown below.

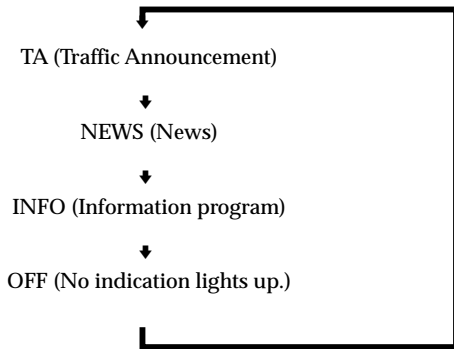

After selecting the type of the program, you can select any other component. When the receiver automatically tunes in the program, the indication that you've selected in Step 2 flashes in the display.

To stop listening to the program

Press RDS EON during program reception. The indication that you've selected in Step 2 lights up and the receiver switches back to the program source or the station you were listening to.

To turn off the EON function

Press RDS EON repeatedly in Step 2 above so that no program type indication lights up in the display.

Notes

- After selecting the type of the program, if you tune in an AM station, the program type indicator turns off and the receiver will no longer tune in the program.
- Be sure to turn off the EON function when you want to record a program without interruptions, especially when doing timer-activated recording.
- "Weak Signal" appears in the display when the signal of the program is weak.

Description of program types

Program type indication	Description
News	News programs
Current Affairs	Topical programs that expand on current news
Information	Programs offering information on a wide spectrum of subjects, including consumer affairs and medical advice
Sport	Sports programs
Education	Educational programs, such as "how-to" and advice programs
Drama	Radio plays and serials
Cultures	Programs about national or regional culture, such as language and social concerns
Science	Programs about the natural sciences and technology
Varied Speech	Other types of programs such as celebrity interviews, panel games, and comedy
Pop Music	Popular music programs
Rock Music	Rock music programs
M.o.R. Music	Easy Listening
Light Classics M	Instrumental, vocal, and choral music
Serious Classics	Performances of major orchestras, chamber music, opera, etc.
Other Music	Music that does not fit into any categories above, such as Rhythm & Blues and Reggae

Program type indication	Description
Weather & Metr	Weather information
Finance	Stock market reports and trading, etc.
Children's Progs	Programs for children
Social Affairs	Programs about people and the things that affect them
Religion	Programs of religious content
Phone In	Programs where members of the public express their views by phone or in a public forum
Travel & Touring	Programs about travel. Not for announcements that are located by TP/TA.
Leisure & Hobby	Programs on recreational activities such as gardening, fishing, cooking, etc.
Jazz Music	Jazz programs
Country Music	Country music programs
National Music	Programs featuring the popular music of the country or region
Oldies Music	Programs featuring oldies music
Folk Music	Folk music programs
Documentary	Investigative features
None	Any programs not defined above

Other Operations

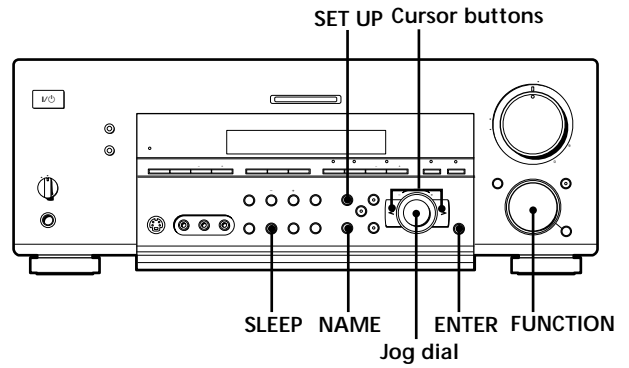

Brief descriptions of buttons that appear in this chapter

NAME button: Press to name preset stations or program sources.

Jog dial: Use to select characters when naming preset stations or program sources.

Cursor buttons (</>): Use to move the cursor when naming preset stations or program sources.

SLEEP button*: Press to activate the sleep function.

FUNCTION control: Rotate to select the tuner or other source.

SET UP button: Press to enter the set up mode.

ENTER button: Press to enter the completed name of the preset station or program source.

* *Except for models of area code CED.*

Naming Preset Stations and Program Sources

You can enter a name of up to 8 characters for preset stations and program sources. These names (for example, "VHS") appear in the receiver's display when a station or program source is selected.

Note that no more than one name can be entered for each preset station or program source.

This function is useful for distinguishing components of the same kind. For example, two VCRs can be specified as "VHS" and "8mm," respectively. It is also handy for identifying components connected to jacks meant for another type of component, for example, a second CD player connected to the MD/DAT jacks.

1 To index a preset station

Rotate **FUNCTION** to select the tuner.
The last station you received is tuned in.

To index a program source

Select the program source (component) to be named, then go to Step 3.

2 Tune in the preset station you want to create an index name for.

If you are not familiar with how to tune in preset stations, see "Tuning to preset stations" on page 46.

3 Press **NAME**.

4 Create an index name by using the jog dial and cursor buttons:

Turn the jog dial to select a character, then press **>** to move the cursor to the next position.

To insert a space

Turn the jog dial until a blank space appears in the display (the space character is between "II" and "A").

If you've made a mistake

Press **<** or **>** repeatedly until the character to be changed flashes, then turn the jog dial to select the right character.

5 Press **ENTER**.

To assign index names to other stations

Repeat Steps 2 to 5.

Note

(Models of area code CED only)

You cannot change the name of an RDS station.

Recording

Your receiver makes it easy to record to and from the components connected to it. You don't have to connect the playback and recording components directly to each other: once you select a program source on the receiver, you can record and edit as you normally would using the controls on each component.

Before you begin, make sure you've connected all components properly.

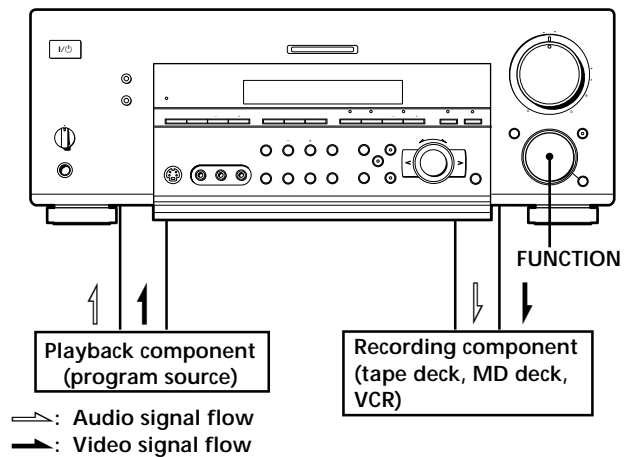

Recording on an audio tape or MiniDisc

You can record on a cassette tape or MiniDisc using the receiver. See the instruction manual of your cassette deck or MD deck if you need help.

- 1 Select the component to be recorded.
- 2 Prepare the component for playing.
For example, insert a CD into the CD player.
- 3 Insert a blank tape or MD into the recording deck and adjust the recording level, if necessary.
- 4 Start recording on the recording deck, then start playback on the playback component.

Notes

- You cannot record a digital audio signal using a component connected to the analog TAPE OUT or MD/DAT OUT jacks (STR-DB940) or the analog MD/TAPE OUT jacks (STR-DB840). To record a digital audio signal, connect a digital component to the DIGITAL MD/DAT OUT jacks (STR-DB940) or the DIGITAL MD/TAPE OUT jacks (STR-DB840).
- Sound adjustments do not affect the signal output from the TAPE OUT or MD/DAT OUT jacks (STR-DB940) or the MD/TAPE OUT jacks (STR-DB840).

Recording on a video tape

You can record from a VCR, a TV, or an LD player using the receiver. You can also add audio from a variety of audio sources when editing a video tape. See your VCR or LD player's instruction manual if you need help.

- 1 Select the program source to be recorded.
- 2 Prepare the component for playing.
For example, insert the laser disc you want to record into the LD player.
- 3 Insert a blank video tape into the VCR (VIDEO 1 or VIDEO 2) for recording.
- 4 Start recording on the recording VCR, then start playing the video tape or laser disc you want to record.

 You can record the sound from any audio source onto a video tape while copying from a video tape or laser disc. Locate the point where you want to start recording from another audio source, select the program source, then start playback. The audio from that source will be recorded onto the audio track of the video tape instead of the audio from the original medium.

To resume audio recording from the original medium, select the video source again.

Notes

- Please be sure to make both digital and analog connections to the TV/SAT and DVD/LD inputs. Analog recording is not possible if you only make digital connections.
- Some sources contain copy guards to prevent recording. In this case, you may not be able to record from the sources.

Using the Sleep Timer

You can set the receiver to turn off automatically at a specified time.

Press **SLEEP** on the front panel (except for models of area code CED) or on the remote while the power is on.

Each time you press **SLEEP**, the time changes as shown below.

→ 2:00:00 → 1:30:00 → 1:00:00 → 0:30:00 → OFF →

The display dims after you have specified the time.

 You can freely specify the time

First, press **SLEEP**, then specify the time you want using the jog dial on the receiver. The sleep time changes in 1 minute intervals. You can specify up to 5 hours.

 You can check the time remaining before the receiver turns off

Press **SLEEP**. The remaining time appears in the display.

Adjustments Using the SET UP Button

The SET UP button allows you to make the following adjustments.

Adjusting the CONTROL A1 II auto function

Turning on the Control A1 II auto function parameter lets you turn Sony components connected via CONTROL A1 cords (see page 13) on automatically when you press the corresponding function button.

Auto function is set to ON by default.

- 1 Press SET UP.
- 2 Press the cursor buttons (< or >) to select "AUTO FUNCTION."
- 3 Turn the jog dial to select "ON" or "OFF."

Setting up the 2 way remote (STR-DB940 only)

This receiver is shipped from the factory with the 2 way remote control system set to "ON". Normally, you can use the receiver as is.

However, if you want to use this receiver together with another component that is also compatible with the 2 way remote control system, be sure to perform the following operation to limit response to signals sent from the remote controls.

To use with the TA-E9000ES

Perform the following steps to turn OFF this unit's 2 way remote control system. Also, be sure the TA-E9000ES is turned on when using this unit.

To use with other components that have the logo

Turn OFF the other component's 2 way remote control system. For details, refer to the operating instructions supplied with your other components.

To use with Sony CD players CDP-CX260 or CDP-CX88ES

Turn OFF the remote control adapter switch on the CDP-CX260 or CDP-CX88ES. For details, refer to the operating instructions supplied with the CDP-CX260 or CDP-CX88ES.

Also when using several 2 way remote control system components together, be sure to place them close together in order to enable proper remote operation.

- 1 Press SET UP.
- 2 Press the cursor buttons (< or >) to select "2 WAY REMOTE".
- 3 Turn the jog dial to select "ON" or "OFF".

Adjustments Using the SET UP Button

Selecting the monitor color system (STR-DB940 of area code other than U, CA)

Select the color system of your TV monitor. You can select either NTSC or PAL. The default setting is PAL.

- 1 Press SET UP.
- 2 Press the cursor buttons (< or >) to select "COLOR SYSTEM".
- 3 Turn the jog dial to select "NTSC" or "PAL".

Selecting the color of the on-screen display (STR-DB940 only)

Select the color of the on-screen display. You can select either COLOR or MONOCHROME. The color of the on-screen display is set to COLOR by default.

- 1 Press SET UP.
- 2 Press the cursor buttons (< or >) to select "OSD COLOR".
- 3 Turn the jog dial to select "COLOR" or "MONOCHROME".

Set the display to turn off

This parameter lets you specify whether or not the display turns off when you press the DIMMER button several times. When "WIDE" is selected, you can set the display to turn off, but when "NARROW" is selected, you cannot set the display to turn off. The default setting is set to "NARROW".

- 1 Press SET UP.
- 2 Press the cursor buttons (< or >) to select "DIMM. RANGE".
- 3 Turn the jog dial to select "NARROW" or "WIDE".

CONTROL A1II Control System

Getting Started

This section explains the basic functions of the CONTROL A1II Control System. Certain components have special functions, like "CD Synchro Dubbing" on cassette decks, that require CONTROL A1II connections. For detailed information regarding specific operations, be sure to also refer to the Operating Instructions supplied with your component(s).

The CONTROL A1II Control System was designed to simplify the operation of audio systems composed of separate Sony components. CONTROL A1II connections provide a path for the transmission of control signals which enable automatic operation and control features usually associated with integrated systems. Currently, CONTROL A1II connections between a Sony CD player, amplifier (receiver), MD deck and cassette deck provide automatic function selection and synchronized recording.

In the future the CONTROL A1II connection will work as a multifunction bus allowing you to control various functions for each component.

Notes

- The CONTROL A1II Control System is designed to maintain upward compatibility as the Control System is upgraded to handle new functions. In this case, however, older components will not be compatible with the new functions.
- Do not operate a 2 way remote control unit when the CONTROL A1II jacks are connected via a PC interface kit to a personal computer running "MD Editor" or similar application. Also, do not operate the connected component in a manner contrary to the functions of the application, as this may cause the application to operate incorrectly.

CONTROL A1II and CONTROL A1 compatibility

The CONTROL A1 control system has been updated to the CONTROL A1II which is the standard system in the SONY 300 disc CD changer and other recent Sony components. Components with CONTROL A1 jacks are compatible with components with CONTROL A1II, and can be connected to each other. Basically, the majority of the functions available with the CONTROL A1 control system will be available with the CONTROL A1II control system.

However, when making connections between components with CONTROL A1 jacks and components with CONTROL A1II jacks, the number of functions that can be controlled may be limited depending on the component. For detailed information, refer to the Operating Instructions supplied with the component(s).

Connections

Connect monaural (2P) mini-plug cords in series to the CONTROL A1II jacks on the back of each component. You can connect up to ten CONTROL A1II compatible components in any order. However, you can connect only one of each type of component (i.e., 1 CD player, 1 MD deck, 1 tape deck and 1 receiver).

(You may be able to connect more than one CD player or MD deck, depending on the model. Refer to the operating instructions supplied with the respective component for details.)

Example

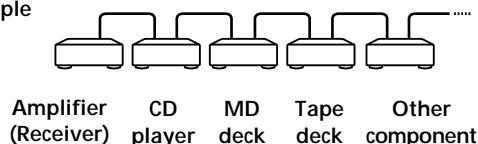

In the CONTROL A1II control system, the control signals flow both ways, so there is no distinction of IN and OUT jacks. If a component has more than one CONTROL A1II jack, you can use either one, or connect different components to each jack.

Jacks and connection examples

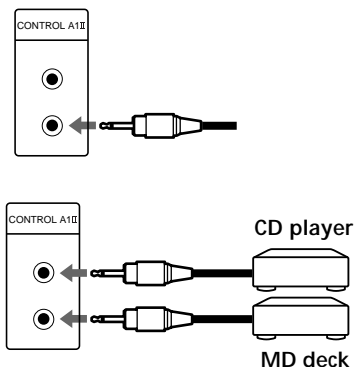

On CONTROL A1 jacks and connections

It is possible to make connections between CONTROL A1 and CONTROL A1II jacks. For details regarding particular connections or setup options, refer to the Operating Instructions supplied with the component(s).

About the connecting cord

Some CONTROL A1 compatible components are supplied with a connecting cord as an accessory. In this case, use the connecting cord for your connection.

When using a commercially available cord, use a monaural (2P) mini-plug cord less than 2 meters long, with no resistance (like the Sony RK-G69HG).

Basic Functions

The CONTROL A1II functions will operate as long as the component you want to operate is turned on, even if all of the other connected components are not turned on.

Automatic function selection

When you connect a CONTROL A1II compatible Sony amplifier (or receiver) to other Sony components using monaural mini-plug cords, the function selector on the amplifier (or receiver) automatically switches to the correct input when you press the play button on one of the connected components.

Notes

- You must connect a CONTROL A1 compatible amplifier (receiver) using a monaural mini-plug cord in order to take advantage of the automatic function selection feature.
- This function only works when the components are connected to the amplifier (or receiver) inputs according to the names on the function buttons. Certain receivers allow you to switch the names of the function buttons. In this case, refer to the Operating Instructions supplied with the receiver.
- When recording, do not play any components other than the recording source. It will cause the automatic function selection to operate.

Synchronized recording

This function lets you conduct synchronized recording between the selected source and recorder components.

- 1 Set the function selector on the amplifier (or receiver) to the source component.
- 2 Set the source component to pause mode (make sure both the ► and || indicators light together).
- 3 Set the recorder component to the REC-PAUSE mode.
- 4 Press PAUSE on the recorder component. The source component is released from the pause mode, and recording begins shortly thereafter. When playback ends from the source component, recording stops.

Notes

- Do not set more than one component to the pause mode.
- Certain recorder components may be equipped with a special synchronized recording function that uses the CONTROL A1II Control System, like "CD Synchro Dubbing". In this case, refer to the Operating Instructions supplied with the recorder component.

Additional Information

Troubleshooting

If you experience any of the following difficulties while using the receiver, use this troubleshooting guide to help you remedy the problem. Also, see “Checking the connections” on page 23 to verify that the connections are correct. Should any problem persist, consult your nearest Sony dealer.

There’s no sound or only a very low-level sound is heard.

- ➔ Check that the speakers and components are connected securely.
- ➔ Make sure that you’ve selected the correct component on the receiver.
- ➔ Make sure that you’ve set the SPEAKERS selector correctly (see page 30).
- ➔ Press MUTING on the remote if the MUTING indicator is lit.
- ➔ The protective device on the receiver has been activated because of a short circuit. Turn off the receiver, eliminate the short-circuit problem and turn on the power again.

The left and right sounds are unbalanced or reversed.

- ➔ Check that the speakers and components are connected correctly and securely.
- ➔ Adjust front balance parameter in the LEVEL menu.

Severe hum or noise is heard.

- ➔ Check that the speakers and components are connected securely.
- ➔ Check that the connecting cords are away from a transformer or motor, and at least 10 feet (3 meters) away from a TV set or fluorescent light.
- ➔ Move your TV away from the audio components.
- ➔ Make sure you’ve grounded \hbar SIGNAL GND terminal.
- ➔ The plugs and jacks are dirty. Wipe them with a cloth slightly moistened with alcohol.

Intermittent sound from a digital source.

- ➔ Make sure signals with 96 kHz sampling frequencies are input to the DVD/LD IN OPTICAL or COAXIAL jacks.

No sound is heard from the center speaker.

- ➔ Make sure the sound field function is on (press SOUND FIELD — MODE).
- ➔ Select a sound field containing the word “cinema” or “virtual” (see page 33–35).
- ➔ Adjust the speaker volume (see page 22).
- ➔ Make sure the center speaker size parameter is set to either SMALL or LARGE (see page 20).

No sound or only a very low-level sound is heard from the rear speakers.

- ➔ Make sure the sound field function is on (press SOUND FIELD – MODE).
- ➔ Select a sound field containing the word “cinema” or “virtual” (see page 33–35).
- ➔ Adjust the speaker volume (see page 22).
- ➔ Make sure the rear speaker size parameter is set to either SMALL or LARGE (see page 20).

The surround effect cannot be obtained.

- ➔ Make sure the sound field function is on (press SOUND FIELD – MODE).
- ➔ Make sure that the SPEAKERS selector is set to A or B (not A+B) if you connected two sets of front speakers.

Recording cannot be done.

- ➔ Check that the components are connected correctly.
- ➔ Select the source component with a FUNCTION button.
- ➔ When recording from a digital component, make sure the input mode is set to ANALOG (see page 27) before recording with a component connected to the analog MD/DAT or TAPE terminals (STR-DB940) or the analog MD/TAPE terminals (STR-DB840).
- ➔ When recording from a digital component, make sure the input mode is set to DIGITAL (see page 27) before recording with the component connected to the DIGITAL MD/DAT OUT terminals (STR-DB940) or the DIGITAL MD/TAPE OUT terminals (STR-DB840).

Radio stations cannot be tuned in.

- ➔ Check that the antennas are connected securely. Adjust the antennas and connect an external antenna if necessary.
- ➔ The signal strength of the stations is too weak (when tuning in with automatic tuning). Use direct tuning.
- ➔ Make sure you set the tuning interval correctly (when tuning in AM stations with direct tuning) (see pages 45 and 59).
- ➔ No stations have been preset or the preset stations have been cleared (when tuning by scanning preset stations). Preset the stations (see page 46).
- ➔ Press DISPLAY so that the frequency appears in the display.

RDS does not work.*

- ➔ Make sure that you're tuned to an FM RDS station.
- ➔ Select a stronger FM station.

The station was interrupted by another station or the receiver automatically starts scanning stations.*

- ➔ The EON function is activated. Turn off the EON function if you don't want the current program to be interrupted.

The RDS information that you want does not appear.*

- ➔ Contact the radio station and find out whether or not they actually provide the service in question. If so, the service may be temporarily out of order.

Nothing appears on the display

- ➔ When the display turns off immediately after the receiver is turned on, press DIMMER to change the display mode.

No picture or an unclear picture appears on the TV screen or monitor.

- ➔ Select the appropriate function on the receiver.
- ➔ Set your TV to the appropriate input mode.
- ➔ Move your TV away from the audio components.

The remote does not function.

- ➔ Point the remote at the remote sensor  on the receiver.
- ➔ Remove any obstacles in the path between the remote and the receiver.
- ➔ Replace both batteries in the remote with new ones, if they are weak.
- ➔ Make sure you select the correct function on the remote.
- ➔ If the remote is set to operate the TV only, use the remote to select a source or component other than TV before operating the receiver or other component.

* Models of area code CED only.

Reference sections for clearing the receiver's memory

To clear	See
All memorized settings	page 18
Customized sound fields	page 41

Specifications

AUDIO POWER SPECIFICATIONS

POWER OUTPUT AND TOTAL HARMONIC DISTORTION:
With 8 ohm loads, both channels driven, from 20 - 20,000 Hz; rated 110 watts (STR-DB940) and 100 watts (STR-DB840) per channel minimum RMS power, with no more than 0.09 % total harmonic distortion from 250 milliwatts to rated output (USA model only).

Amplifier section

POWER OUTPUT

Models of area code U, CA

Rated Power Output at Stereo Mode
 (8 ohms 20 Hz – 20 kHz, THD 0.09 %)

STR-DB940: 110 W + 110 W
 STR-DB840: 100 W + 100 W
 (4 ohms 20 Hz – 20 kHz, THD 0.09 %)
 STR-DB940: 100 W + 100 W
 STR-DB840: 90 W + 90 W

Reference Power Output
 (8 ohms 20 Hz – 20 kHz, THD 0.09 %)

STR-DB940: FRONT¹⁾:
 110 W + 110 W
 CENTER¹⁾: 110 W
 REAR¹⁾:
 110 W + 110 W
 STR-DB840: FRONT¹⁾:
 100 W + 100 W
 CENTER¹⁾: 100 W
 REAR¹⁾:
 100 W + 100 W

(4 ohms 20 Hz – 20 kHz, THD 0.09 %)

STR-DB940: FRONT¹⁾:
 100 W + 100 W
 CENTER¹⁾: 100 W
 REAR¹⁾:
 100 W + 100 W
 STR-DB840: FRONT¹⁾:
 90 W + 90 W
 CENTER¹⁾: 90 W
 REAR¹⁾:
 90 W + 90 W

Models of other area code

Rated Power Output at Stereo Mode
 (8 ohms 1 kHz, THD 0.7 %)

STR-DB940: 110 W + 110 W²⁾
 100 W + 100 W³⁾
 STR-DB840: 100 W + 100 W
 (4 ohms 1 kHz, THD 0.7 %)
 STR-DB940: 100 W + 100 W²⁾
 90 W + 90 W³⁾
 STR-DB840: 90 W + 90 W

Reference Power Output²⁾
 (8 ohms 1 kHz, THD 0.7 %)

STR-DB940: FRONT¹⁾:
 110 W + 110 W
 CENTER¹⁾: 110 W
 REAR¹⁾:
 110 W + 110 W
 STR-DB840: FRONT¹⁾:
 100 W + 100 W
 CENTER¹⁾: 100 W
 REAR¹⁾:
 100 W + 100 W

(4 ohms 1 kHz, THD 0.7 %)

STR-DB940/DB840:
 FRONT¹⁾:
 100 W + 100 W
 CENTER¹⁾: 100 W
 REAR¹⁾:
 100 W + 100 W

(8 ohms 20 Hz – 20 kHz, THD 0.09 %)

STR-DB940: FRONT¹⁾:
 100 W + 100 W
 CENTER¹⁾: 100 W
 REAR¹⁾:
 100 W + 100 W
 STR-DB840: FRONT¹⁾:
 90 W + 90 W
 CENTER¹⁾: 90 W
 REAR¹⁾:
 90 W + 90 W

(4 ohms 20 Hz – 20 kHz, THD 0.09 %)

STR-DB940/DB840:
 FRONT¹⁾:
 90 W + 90 W
 CENTER¹⁾: 90 W
 REAR¹⁾:
 90 W + 90 W

1) Depending on the sound field settings and the source, there may be no sound output.

2) Measured under the following conditions:

Area code	Power requirements
AU	240 V AC, 50 Hz
CN, SP, CED	230 V AC, 50 Hz

3) Measured under the following conditions:

Area code	Power requirements
CN	220 V AC, 50 Hz

Frequency response

PHONO: RIAA
equalization curve
±0.5 dB
CD, TAPE, MD/DAT,
MD/TAPE, DVD/
LD, TV/SAT,
VIDEO 1, 2, and
VIDEO 3:
10 Hz – 100 kHz
+0.5/-3 dB (with
sound field,
equalizer, and bass
boost bypassed)

Inputs (Analog)

PHONO:
Sensitivity: 2.5 mV
Impedance: 50
kilohms
S/N⁴⁾: 86 dB
(A, 2.5 mV⁵⁾)
5.1CH INPUT, CD,
TAPE, MD/DAT,
MD/TAPE, DVD/
LD, TV/SAT, VIDEO
1, 2, and VIDEO 3:
Sensitivity: 150 mV
Impedance:
50 kilohms
S/N⁴⁾: 96 dB
(A, 150 mV⁵⁾)

4) INPUT SHORT

5) Weighted network, input level

Inputs (Digital)

DVD/LD IN(Coaxial):
Sensitivity: –
Impedance: 75 ohms
S/N: 100 dB
(A, 20 kHz LPF)
DVD/LD IN, TV/SAT
IN, MD/DAT IN
(Optical):
Sensitivity: –
Impedance: –
S/N: 100 dB
(A, 20 kHz LPF)

Outputs

TAPE, MD/DAT, MD/
TAPE (REC OUT);
VIDEO 1, 2 (AUDIO
OUT):
Voltage: 150 mV,
Impedance:
1 kilohms
FRONT L/R, CENTER,
REAR L/R,
SUB WOOFER:
Voltage: 2 V
Impedance:
1 kilohms
PHONES:
Accepts low- and
high-impedance
headphones

BASS BOOST +6 dB at 70 Hz

Sampling Frequency

48 kHz

EQ

BASS:
100 Hz~1.0 kHz
(21 steps)
MID:
500 Hz~5.0 kHz
(21 steps)
TREBLE:
1.0 kHz~10 kHz
(21 steps)
Gain levels:
±10 dB, 1 dB step

FM tuner section

Tuning range 87.5 - 108.0 MHz

Antenna terminals

75 ohms, unbalanced

Sensitivity Mono: 18.3 dBf,
2.2 µV/75 ohms
Stereo: 38.3 dBf,
22.5 µV/75 ohms

Usable sensitivity

11.2 dBf, 1 µV/75 ohms

S/N

Mono: 76 dB
Stereo: 70 dB

Harmonic distortion at 1 kHz

Mono: 0.3%
Stereo: 0.5%

Separation 45 dB at 1 kHz

Frequency response

30 Hz – 15 kHz
+0.5/-2 dB

Selectivity 60 dB at 400 kHz

Specifications

AM tuner section

Tuning range	
Models of area code U, CA	With 10-kHz tuning scale: 530 – 1710 kHz ⁵⁾
	With 9-kHz tuning scale: 531 – 1710 kHz ⁵⁾
Models of area code AU, CN, SP, CED	With 9-kHz tuning scale: 531 – 1602 kHz
Antenna	Loop antenna
Usable sensitivity	50 dB/m (at 1,000 kHz or 999 kHz)
S/N	54 dB (at 50 mV/m)
Harmonic distortion	0.5 % (50 mV/m, 400 kHz)
Selectivity	At 9 kHz: 35 dB At 10 kHz: 40 dB

5) You can change the AM tuning scale to 9 kHz ↔ 10 kHz. After tuning in any AM station, turn off the receiver. Hold down the TUNING – button and press the V/⏪ button. All preset stations will be erased when you change the tuning scale. To reset the scale to 10 kHz (or 9 kHz), repeat the procedure.

Video section

Inputs	Video: 1 Vp-p 75 ohms S-video: Y: 1 Vp-p 75 ohms C: 0.286 Vp-p 75 ohms
Outputs	Video: 1 Vp-p 75 ohms S-video: Y: 1 Vp-p 75 ohms C: 0.286 Vp-p 75 ohms

General

System	Tuner section: PLL quartz-locked digital synthesizer system Preamplifier section: Low-noise NF type equalizer Power amplifier section: Pure-complementary SEPP
Power requirements	Models of area code U, CA 120 V AC, 60 Hz Models of area code CED 230 V AC, 50/60 Hz Models of area code CN, SP 220 – 230 V AC, 50/60 Hz Models of area code AU 240 V AC, 50 Hz
Power consumption	Models of area code U STR-DB940: 290 W STR-DB840: 280 W Models of area code CA STR-DB940: 400 VA STR-DB840: 390 VA Models of area code CED STR-DB940: 290 W STR-DB840: 280 W Models of area code CN, SP, AU STR-DB940: 290 W

AC outlets

Models of area code U, CA	2 switched, total 120 W/1A
Models of area code AU, SP, CED	1 switched, total 100 W
Models of area code CN	2 switched, total 100 W
Dimensions	430 × 161 × 401 mm (17 × 7 ⁷ / ₈ × 19 ⁵ / ₈ in.) including projecting parts and controls
Mass (Approx.)	13.2 kg (29 lb 2 oz)
Supplied accessories	See page 4.

For details on the area code of the component you are using, see page 3.

Design and specifications are subject to change without notice.

Glossary

Surround sound

Sound that consists of three elements: direct sound, early reflected sound (early reflections) and reverberative sound (reverberation). The acoustics of the surrounding space affect the way these three sound elements are heard. Surround sound combines these sound elements in such a way that you actually can sense the size of the venue, as well as its type.

- Types of sound

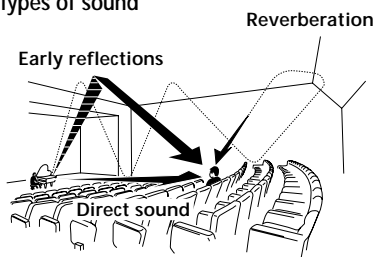

- Transition of sound from rear speakers

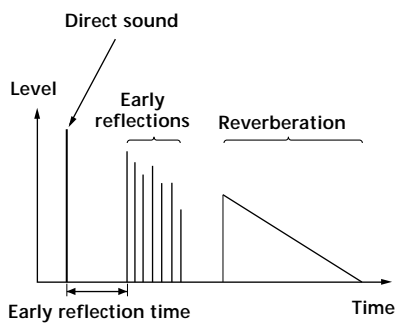

Dolby Pro Logic Surround

As one method of decoding Dolby Surround, Dolby Pro Logic Surround produces four channels from two-channel sound. Compared with the former Dolby Surround system, Dolby Pro Logic Surround reproduces left-to-right panning more naturally and localizes sounds more precisely. To take full advantage of Dolby Pro Logic Surround, you should have one pair of rear speakers and a center speaker. The rear speakers output monaural sound.

Dolby Digital (AC-3)

This sound format for movie theaters is more advanced than Dolby Pro Logic Surround. In this format, the rear speakers output stereo sound with an expanded frequency range and a sub woofer channel for deep bass is independently provided. This format is also called "5.1" because the sub woofer channel is counted as 0.1 channel (since it functions only when a deep bass effect is needed). All six channels in this format are recorded separately to realize superior channel separation. Furthermore, since all the signals are processed digitally, less signal degradation occurs. The name "AC-3" comes from the fact that it is the third audio coding method to be developed by the Dolby Laboratories Licensing Corporation.

Digital Cinema Sound

This is the generic name of the surround sound produced by digital signal processing technology developed by Sony. Unlike previous surround sound fields mainly directed at the reproduction of music, Digital Cinema Sound is designed specifically for the enjoyment of movies.

Tables of Settings Using SUR, LEVEL, EQ, and SET UP buttons

You can make various settings using the LEVEL, SUR, EQ, SET UP buttons, jog dial, and cursor buttons. The tables below show each of the settings that these buttons can make.

Press and light	Press < or > to select	Turn jog dial to select	See page
SUR button	EFFECT LEVEL	depends on sound mode (in 21 steps)	38
	WALL TYPE	between -8 to +8 (in 1 increment steps)	
	REVERBERATION TIME	between -8 to +8 (in 1 increment steps)	
	SCREEN DEPTH	OFF, MID, DEEP	
	VIRTUAL SPEAKER	ON, OFF	
LEVEL button	FRONT BALANCE	between -8 dB to +8 dB (in 1 dB steps)	39
	REAR BALANCE	between -8 dB to +8 dB (in 1 dB steps) (during 5.1CH input: -4 dB ~ +4 dB (in 1 dB steps))	
	REAR LEVEL	between -10 dB to +10 dB (in 1 dB steps) (during 5.1 CH input: -6 dB ~ +10 dB (in 1 dB steps))	
	CENTER LEVEL	between -10 dB to +10 dB (in 1 dB steps)	
	SUB WOOFER LEVEL	between -10 dB to +10 dB (in 1 dB steps)	
	LFE MIX LEVEL	OFF, or -20 dB to 0 dB (in 1 dB steps)	
	dtS LFE MIX LEVEL	OFF, or -20 dB to +10 dB (in 1 dB steps)	
	DYNAMIC RANGE COMP	Off, 0.1 to 0.9 (in 0.1 dB steps), STD, or MAX	
EQ button	FRONT BASS GAIN	between -10 dB to +10 dB (in 1 dB steps)	40
	FRONT BASS FREQUENCY	between 100 Hz and 1.0 kHz (in 21 steps)	
	FRONT MID GAIN	between -10 dB to +10 dB (in 1 dB steps)	
	FRONT MID FREQUENCY	between 500 Hz and 5.0 kHz (in 21 steps)	
	FRONT TREBLE GAIN	between -10 dB to +10 dB (in 1 dB steps)	
	FRONT TREBLE FREQUENCY	between 1.0 kHz and 10 kHz (in 21 steps)	
	CENTER BASS GAIN	between -10 dB to +10 dB (in 1 dB steps)	
	CENTER BASS FREQUENCY	between 100 Hz and 1.0 kHz (in 21 steps)	
	CENTER MID GAIN	between -10 dB to +10 dB (in 1 dB steps)	
	CENTER MID FREQUENCY	between 500 Hz and 5.0 kHz (in 21 steps)	
	CENTER TREBLE GAIN	between -10 dB to +10 dB (in 1 dB steps)	
	CENTER TREBLE FREQUENCY	between 1.0 kHz and 10 kHz (in 21 steps)	
	REAR BASS GAIN	between -10 dB to +10 dB (in 1 dB steps)	
	REAR BASS FREQUENCY	between 100 Hz and 1.0 kHz (in 21 steps)	
	REAR MID GAIN	between -10 dB to +10 dB (in 1 dB steps)	
	REAR MID FREQUENCY	between 500 Hz and 5.0 kHz (in 21 steps)	
	REAR TREBLE GAIN	between -10 dB to +10 dB (in 1 dB steps)	
	REAR TREBLE FREQUENCY	between 1.0 kHz and 10 kHz (in 21 steps)	

Press	Press < or > to select	Turn jog dial to select	See page	
SET UP	FRONT [XXX]	LARGE or SMALL	19	
	CENTER [XXX]	LARGE, SMALL, or NO		
	REAR [XXX]	LARGE, SMALL, or NO		
	REAR PLACE [XXX]	SIDE, MIDDLE, or BEHIND		
	REAR HEIGHT [XXX]	LOW or HIGH		
	SUB WOOFER [XXX]	YES or NO		
	FRONT XX.X FEET ³⁾ (METER)	between 3 feet ³⁾ (1.0 meters) and 40 feet ³⁾ (12.0 meters) (in 1 foot ³⁾ (0.1 meter) steps)		
	CENTER XX.X FEET ³⁾ (METER)	between FRONT and 5 feet ³⁾ (1.5 meters) (in 1 foot ³⁾ (0.1 meter) steps)		
	REAR XX.X FEET	between FRONT and 15 feet ³⁾ (4.5 meters) (in 1 foot ³⁾ (0.1 meter) steps)		
	DIST. UNIT [XXX]	feet or meter		
	FRONT SP > XXX Hz ¹⁾	60 Hz, 90 Hz, 120Hz, 150Hz, 180Hz		
	CENTER SP > XXX Hz ¹⁾	60 Hz, 90 Hz, 120Hz, 150Hz, 180Hz		
	REAR SP > XXX Hz ¹⁾	60 Hz, 90 Hz, 120Hz, 150Hz, 180Hz		
	AUTO FUNCTION [XXX]	ON, OFF		53
	2 WAY REMOTE [XXX] ²⁾	ON, OFF		
	COLOR SYSTEM [XXX] ²⁾⁴⁾	PAL, NTSC		54
OSD [XXX] ²⁾	COLOR, MONOCHROME			
DIMM. RANGE [XXX]	NARROW, WIDE			

¹⁾ When the speakers are set to SMALL only.

²⁾ STR-DB940 only.

³⁾ Models of area code U, CA only.

⁴⁾ Except for models of area code U, CA.

Index

A

- AC-3. *See Dolby Digital (AC-3)*
- Adjusting
 - brightness of the display 28
 - equalizer 40
 - speaker volumes 22
 - surround parameters 38
- Autobetical 44
- Automatic tuning 45

B

- Basic operations 26~30
- Battery 4

C

- Changing
 - display 28
 - effect level 38
- Checking the connections 23
- Clearing receiver's memory 18
- Connecting 4~14
- Crossover frequency 22
- Customizing sound fields 38~42

D

- Digital Cinema Sound 61
- Dimmer Range 54
- Direct tuning 45
- Dolby Digital (AC-3) 61
- Dolby Pro Logic Surround 61
- Dubbing. *See Recording*

E, F, G

- Editing. *See Recording*
- Effect level 38
- EON 47
- EQ 40

H

- Hookups
 - 5.1 CH input 11
 - AC power cord 14
 - antennas 5
 - audio components 6, 7
 - digital components 9, 10
 - CONTROL A1 II 13
 - S-LINK CONTROL S 13
 - speaker system 16
 - video components 8

I, J, K

- Indexing. *See Naming*

L

- Labeling. *See Naming*

M

- Monitor 54

N

- Naming 51

O

- OSD 54

P, Q

- Parameter 41, 42, 62, 63
- Preset stations
 - how to preset 46
 - how to tune 46
- PTY 47

R

- RDS 47~49
- Receiving broadcasts
 - automatically 45
 - directly 45
 - preset stations 46
- Recording
 - on an audio tape or MD 51
 - on a video tape 52

S

- Scanning
 - preset stations. *See Preset tuning*
 - radio stations. *See Automatic tuning*
- Selecting
 - component 26
 - front speaker system 30
 - sound field 32
- Sleep timer 52
- Sound field
 - adjustable parameters 41, 42
 - customizing 38~42
 - pre-programmed 33~35
 - resetting 41
 - selecting 32
- Speakers
 - adjusting speaker volume 22
 - connection 16

- impedance 17
- placement 19~22
- Supplied accessories 4
- Surround sound 31~42

T

- Test tone 22
- Tuning
 - automatically 45
 - directly 45
 - preset stations 46

U, V, W, X, Y, Z

- Unpacking 4